



ISO9001:2008 Quality Management System Authentication
CE Authentication



EDS800 series

0.2-3.7KW

mini type

Ver. 4.0

Users' Manual

SHENZHEN ENCOM ELECTRIC TECHNOLOGIES CO., LTD

Foreword

Encom products are designed and produced according to EN61800-5-1: 2007, EN 61010-1: 2010, EN61800-3: 2004+A1: 2012 standards under ISO9001:2008 quality management system.

Thank you for purchasing EDS800 series mini universal inverter from Shenzhen Encom Electric Technologies CO., LTD.

EDS800 series can fulfill all kinds of demand for general-purpose inverter by advanced control manner which make high torque, high precision and wide-range speed regulation drive be available. EDS800 is organic combine of customer's general need and industrial requirement to provide practical PID adjuster, simple PLC, programmable input output terminal control, long-distance synchronous control, impulse frequency provision and other special inverter control with powerful function for customer and to provide highly-integrated incorporative solution of high value for reducing system cost and improving system reliability for device manufacturing and automatization engineering customers.

EDS800's big torque low noise and low electromagnetic disturbance during operation can fulfill customer's environmental protection requirement by space voltage vector PWM control technique and electromagnetic compatibility unitary design.

Assembling wiring, parameter setting, troubleshooting and daily maintenance notice are available in this manual. To make sure that you can correctly assemble and operate EDS800 series inverters to exert their excellent performance, please read this user manual detailedly before you assemble the device and conserve the manual appropriately before the end-user get them.

Please contact our office or dealer in all places at any moment if you have any doubts or special demands when using these inverters, and you can also contact our after service center in our headquarters directly. We will serve you with all our heart.

We reserve our right to notice you if we change contents of this manual.

Contents

1 Safety information and use notice points	1
1.1 Safety precautions.....	1
1.2 Use range	2
1.3 Use notice points	2
1.4 Scrap notice points.....	3
2 Type and specification of the inverter	4
2.1 Incoming inverter inspect.....	4
2.2 Type explanation	4
2.3 Nameplate explanation	4
2.4 Series type explanation.....	5
2.5 Appearance and parts name explanation.....	5
2.6 Outer size and gross weight.....	6
2.7 Outer size of keypad and its fixing box (unit: mm)	6
2.8 Product technic index and spec.	7
3 Installation and wiring	9
3.1 Installation ambient.....	9
3.1.1 Demand for installation ambient	9
3.1.2 Installation direction and space.....	9
3.2 Parts disassembly and installation.....	9
3.2.1 Key board disassembly and installation.....	9
3.2.2 Plastic cover disassembly.....	10
3.3 Wiring notice points	10
3.4 Main loop terminal wiring.....	11
3.4.1 Connection between inverter and fitting parts	11
3.4.2 Main loop terminal wiring.....	12
3.5 Basic running wiring diagram	13
3.6 Control loop collocation and wiring.....	13
3.6.1 Location&function of terminal and jump-wire	13
3.6.2 Explanation for control CPU board.....	15
3.6.3 Analog input output terminal wiring.....	17
3.6.4 Communication terminal wiring	18
3.7 Installation guide for anti-jamming.....	19
3.7.1 Restraining to noise disturbance	19
3.7.2 Local wiring and earthing	21
3.7.3 Relation of long-distance wiring and current leak and the	

countermeasure.....	22
3.7.4 Installation demand for electromagnetic on-off electronic device	22
4 Run and operation explanation for inverter.....	23
4.1 Run of inverter.....	23
4.2 Operation and use of key board.....	25
4.3 Inverter electrification	32
5 Function parameter schedule graph.....	33
5.1 Symbol description.....	33
5.2 Function parameter schedule graph.....	35
6 Detailed function description	48
6.1 Basic run function parameter group: F0.....	48
6.2 Start-up, stop, braking function parameter group: F1	53
6.3 Auxiliary run function parameter group: F2	56
6.4 Closed-loop run control parameter: F3	65
6.5 Simple PLC run function parameter group: F4.....	73
6.6 Terminal correlative function parameter group: F5.....	78
6.7 Traverse special function parameter group: F6.....	89
6.8 Frequency provision function parameter group: F7.....	91
6.9 Motor and vector control function parameter group: F8.....	93
6.10 Protection function parameter: F9.....	94
6.11 Failure record function parameter: Fd.....	97
6.12 Code and manufacturer function parameter: FF	98
7 Troubleshooting.....	99
7.1 Failure and countermeasure.....	99
7.2 Failure record lookup.....	102
7.3 Failure reset	102
8 Maintenance.....	104
8.1 Routine maintenance	104
8.2 Inspection and replacement of damageable parts.....	104
8.3 Repair guarantee	105
8.4 Storage	105
9 Examples	106
9.1 Common speed regulation running	106
9.2 Terminal control running.....	107
9.3 Multi-step speed control running	108
9.4 Closed-loop control system.....	109
9.5 Consecutive action running.....	110

10 Modbus communication protocol	111
10.1 Summarization.....	111
10.2 Communication net buildup mode	111
10.3 Communication mode	111
10.4 RTU Communication Mode.....	112
10.5 Data communication address allocation.....	114
10.6 Communication error processing	115
10.7 Data frames examples.....	115
10.8 CRC checksum mode	116
Appendix 1 Serial port 485 communication protocol	118
Appendix 2 Braking resistance	127

1 Safety information and use notice points

In order to ensure the safety of your personal and equipment, before using the inverter, please read this chapter of contents conscientiously.

1.1 Safety precautions

There are three kinds of safe relevant warnings in this service manual, they are as follows:



This symbol explains items that need to be paid attention to when being operated.



Note

This symbol is briefed on some useful information.



This symbol briefs on: If does not operate on request, may cause death, severely injured or serious property loss.

(1) Forbid to connect U, V, W output end to AC power supply, otherwise cause the complete damage of the inverter.

(2) Don't make P- and P + short-circuited, otherwise cause the inverter to be damaged.

(3) The inverter is forbidden to install on the flammables, otherwise have danger of fire.

(4) Don't install it in the environment with explosive gas, otherwise have danger of causing explosion.

(5) After connecting main loop, should carry on insulating treatment to bare wiring end, otherwise have danger of getting an electric shock.

(6) If being connected to the power supply, don't operate the inverter with moist hands, otherwise have danger of getting an electric shock.

(7) The ground terminal of the inverter must be grounded well.

(8) Inverter being connected to power supply, please don't open cover and carry on wiring, can connect the wire or check only after closing power for 10 minutes.

(9) Only qualified personnel may carry on wiring and forbid leaving over any conductive thing in machine, otherwise have danger of getting an electric shock or causing damage of the inverter.

(10) Inverter stored for over 2 years, should be stepped up gradually with voltage regulator first while having the electricity, otherwise have danger of getting electric shock and explosion.





- (1) It is prohibited that connect AC220V signal to control ends except TA, TB, TC, otherwise have danger of damaging property.
- (2) If the inverter is damaged or without all parts, please don't install and operate it, otherwise have danger of fire or cause personnel to be injured.
- (3) When installing, should choose a place where can endure the inverter, otherwise have danger of injuring personnel or damaging property while falling down.

1.2 Use range

- (1) This inverter is only suitable for three phases AC asynchronous motor in general industrial field.
- (2) While applying inverter to such equipments that relate much to the life, great property, safety devices etc., must handle cautiously, and consult with producer, please.
- (3) This inverter belongs to the control device of general industrial motor, if used in dangerous equipment, must consider the security safeguard procedures when the inverter breaks down.

1.3 Use notice points

- (1) EDS800 series inverter is voltage-type inverter, so temperature, noise and vibration slightly increasing compared to power source running when using, belongs to normal phenomenon.
- (2) If need to run for a long time with constant torque of low-speed, must select motor of frequency conversion for use. Use general asynchronous AC motor when running at a low speed, should control temperature of the motor or carry on heat dissipation measure forcedly, so as not to burn the generator.
- (3) Such mechanical device needing lubricating as the gearbox and gear wheel, etc., after running at a low speed for a long time, may be damaged as lubrication result become poor, please take necessary measure in advance.
- (4) When the motor running with frequency above specified, besides considering the vibration, noise increase of the motor, must also confirm speed range of the motor bearing and the mechanical device.
- (5) For hoist and great inertia load, etc., the inverter would shut off frequently due to over-current or over-voltage failure, in order to guarantee normal work, should consider choosing proper brake package.
- (6) Should switch ON/OFF the inverter through terminal or other normal order channels. It is prohibited that switch ON/OFF the inverter frequently by using strong electric switch such as magnetic control conductor, otherwise will cause the equipment to be damaged.
- (7) If need to install such switch as the magnetic control conductor, etc.

between inverter output and the motor, please guarantee the inverter is switched ON/OFF without output, otherwise may damage the inverter.

(8) The inverter may meet with mechanical resonance of the load within certain range of frequency output, can set up jumping frequency to evade.

(9) Before using, should confirm the voltage of the power is within the working voltage range allowed, otherwise should vary voltage or order special inverter.

(10) In the condition of altitude above 1000 meters, should use the inverter in lower volume, reduce output current by 10% of specified current after each 1500 meters height increasing.

(11) Should make insulation check to the motor before using it for the first time or after a long time placement. Please inspect with 500V voltage-type megohm meter according to method shown as graph1-1 and insulation resistance should not be smaller than 5 M Ω , otherwise inverter may be damaged.

(12) To forbid assembling capacitor for improving power factor or lightningproof voltage-sensible resistance etc., otherwise will cause malfunction trip of the inverter or damage of the parts, shown as graph 1-2.

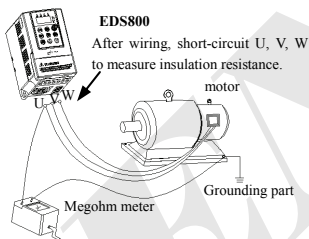

Fig.1-1 Motor insulation measure

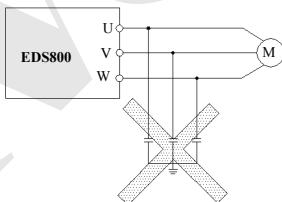

Fig.1-2 Capacitor at output side forbidden

1.4 Scrap notice points

When disposing scrap inverter and its parts, please note:

- (1) The unit: please discard as industrial useless.
- (2) Electrolytic capacitor: when burning the inverter electrolytic capacitor in it may explode.
- (3) Plastic: when plastic, rubber parts etc. in the inverter are burning, they may bring bad, poisonous gas, so please be ready to safeguards.

2 Type and specification of the inverter

2.1 Incoming inverter inspect

(1) Check if there is damage during transportation and inverter itself has damage or fall-off parts.

(2) Check if parts presented in packing list are all ready.

(3) Please confirm rated data of the inverter is in line with your order requirement.

Our product is guaranteed by strict quality system during manufacturing, packing, transportation etc., please contact our company or local agent rapidly if some careless omission or mistake arise, we'll deal with it as soon as possible.

2.2 Type explanation

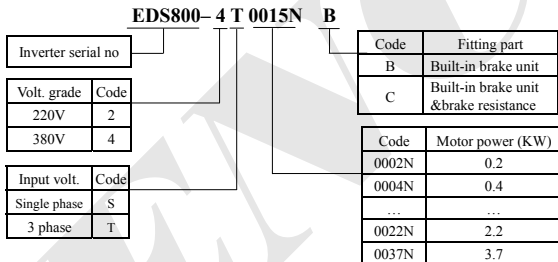

Fig.2-1 Type description



If the inverter hasn't relevant content or can be defaulted, code after "/" will be ignored.

2.3 Nameplate explanation

Nameplate presented as Fig.2-2 with type and rating data at the bottom of inverter right side.

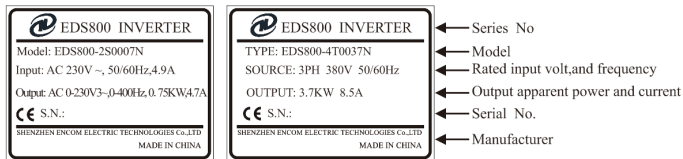

Fig.2-2 Nameplate

2.4 Series type explanation

Table 2-1 Series type explanation

Inverter type	Rated power (KVA)	Rated output current (A)	Adapted motor (KW)
EDS800-2S0002NB	0.6	1.6	0.2
EDS800-2S0004NB	1.1	3	0.4
EDS800-2S0007NB	1.8	4.7	0.75
EDS800-2S0015NB	2.8	7.5	1.5
EDS800-2S0022N	3.8	10	2.2
EDS800-4T0007NB	1.5	2.3	0.75
EDS800-4T0015NB	2.4	3.7	1.5
EDS800-4T0022N	3.3	5	2.2
EDS800-4T0037N	5.6	8.5	3.7

2.5 Appearance and parts name explanation

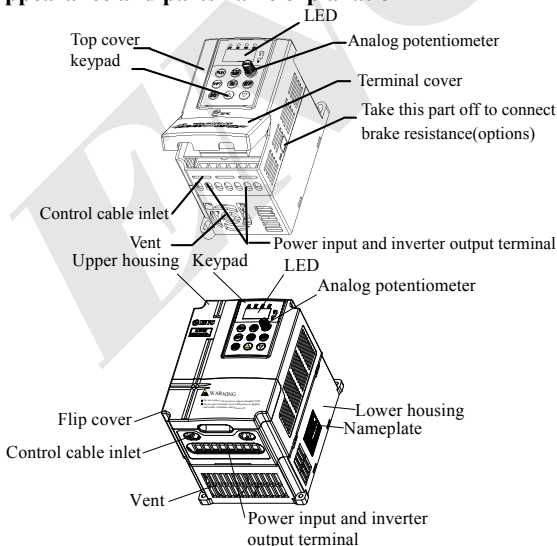

Fig. 2-3 Parts name sketch for EDS800

2.6 Outer size and gross weight

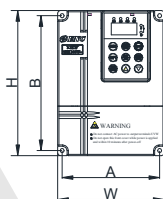
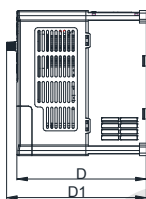
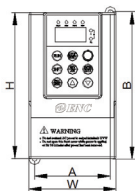
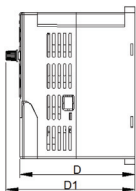

Fig.a

Fig.b

Fig.2-4 Outline Image
Table 2-2 Mounting size

Inverter type	W (mm)	H (mm)	D (mm)	D1 (mm)	A (mm)	B (mm)	Fixing aperture (mm)	Gross weight (kg)	Fig. No.
EDS800-2S0002NB	89	148.5	112.5	124.7	74	138	5	1	Fig.a
EDS800-2S0004NB	89	148.5	112.5	124.7	74	138	5	1	Fig.a
EDS800-2S0007NB	89	148.5	112.5	124.7	74	138	5	1.1	Fig.a
EDS800-2S0015NB	89	148.5	112.5	124.7	74	138	5	1.2	Fig.a
EDS800-2S0022N	125	170	152.1	164.1	114.5	158	5	1.9	Fig.b
EDS800-4T0007NB	89	148.5	112.5	124.7	74	138	5	1.1	Fig.a
EDS800-4T0015NB	89	148.5	112.5	124.7	74	138	5	1.1	Fig.a
EDS800-4T0022N	125	170	152.1	164.1	114.5	158	5	1.9	Fig.b
EDS800-4T0037N	125	170	152.1	164.1	114.5	158	5	1.9	Fig.b

2.7 Outer size of keypad and its fixing box (unit: mm)

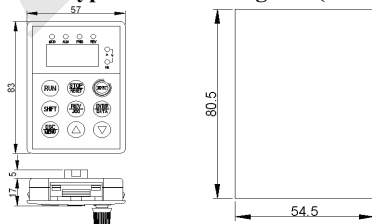

Fig.2-5 Outer size of keypad and outline of its fixing box

2.8 Product technic index and spec.

Item		Item description	
Input	Rating volt.,frequency	3 phase 380V, 50Hz/60Hz; single phase 220V, 50Hz/60Hz	
	Allowed work volt. range	3 phase voltage: 320V~460V; single phase voltage: 200V~260V	
Output	Voltage	380V grade: 0~380V; 220V grade: 0~220V	
	Frequency	0Hz-400Hz	
	Over loading capacity	150% of rating current for 1 minute, 200% of rating current for 0.5 second;	
Control performance	Control mode	Optimum space voltage vector SVPWM constant volt. Frequency ratio V/F control	
	Speed regulation range	1:100	
	Start-up torque	100% of rating torque at low frequency	
	Running speed stable state precision	$\leq \pm 0.5\%$ of rating synchronous speed	
	Frequency precision	Digital setting: max. frequency $\times \pm 0.01\%$; analog setting: max.frequency $\times \pm 0.5\%$	
	Frequency resolution	Analog setting	0.1% of max. frequency+96
		Digital setting	0.01Hz
		Exterior pulse	0.5% of max. frequency
	Torque boost	Automatic torque boost, manual torque boost 0.1%~20.0%	
	V/F curve (volt. frequency characteristic)	Set rating frequency randomly at range of 5~400Hz, can choose constant torque, degressive torque 1, degressive torque 2, degressive torque 3 in total 4 kinds of curve	
	Accelerating decelerating curve	2 modes: straight line accelerating decelerating and S curve accelerating decelerating; 7 kinds of accelerating decelerating time (unit minute/second can be optioned), max. time 6000 minutes.	
	Brake	Power consumption brake	Exterior brake resistance
		DC brake	Optional start-up and stop, action frequency 0~15Hz, action volt. 0~15%, action time 0~20.0 s
	Jog	Jog frequency range: 0.50Hz~50.00Hz; jog accelerating decelerating time 0.1~60.0s can be set	
	Multisection speed running	Realized by interior PLC or control terminal	
Interior PID controller	Be convenient to make closed-loop system		
Automatic energy save running	Optimize V/F curve automatically based on the load to realize power save running		
Automatic volt. regulation (AVR)	Can keep constant output volt. When power source voltage varies.		
Automatic current limiting	Limit running current automatically to avoid frequent over-current which will cause trip		

Running function	Running order specified channel	Key pad specified, control terminal specified, serial port specified
	Running frequency specified channel	Digital provision, analog provision, impulse provision, serial port provision, combined provision, can be switched at any time by kinds of method
	pulse output channel	Impulse square wave signal output of 0~20KHz, can realize output of physical parameter such as setting frequency, output frequency etc.
	Analog output channel	1 channel of analog signal output, AO channel can be 4~20mA or 0~10V; through it the inverter can realize output of physical parameter such as setting frequency, output frequency etc.
Keypad	LED display	Can display setting frequency, output frequency, output voltage, output current etc. in total 14 kinds of parameter
	Lock the button	Lock all or part of the buttons(analog potentiometer can't be locked)
Protection function		Over-current protection, over-voltage protection, lack-voltage protection, over-heat protection, over-load protection, missing phase protection (in option) etc.
Fitting parts		Brake subassembly, remote-control keypad, connecting cable for remote-control keypad etc.
Ambient	Use ambient	Indoor, not bare to sunlight, no dust, no corrosive gas, no flammable gas, no oil fog, no vapor, no water drop or salt etc.
	Altitude	Lower than 1000m
	Ambient temperature	-10°C~+40°C(under ambient temperature 40°C~50°C, please reduce the volume or strengthen heat sink)
	Ambient humidity	Smaller than 95%RH, no condensation water
	Vibration	Smaller than 5.9m/s ² (0.6g)
	Storage temperature	-40°C~+70°C
Config-uration	Defending grade	IP20
	Cooling mode	By fan with automatic temperature control
Mounting mode		Wall hanging



Note

To exert excellent performance of this inverter, please choose correct type and check relevant content according to this chapter before wiring for use.



Must choose correct type, otherwise may cause abnormal running of the motor or damage of the inverter.

3 Installation and wiring

3.1 Installation ambient

3.1.1 Demand for installation ambient

- (1) Installed in drafty indoor place, ambient temperature within $-10^{\circ}\text{C}\sim 40^{\circ}\text{C}$, need external compulsory heat sink or reduce the volume if temperature exceeds 40°C .
- (2) Avoid installing in place with direct sunlight, much dust, floating fibre and metal powder.
- (3) Forbid to install in place with corrosive, explosible gas.
- (4) Humidity should be smaller than 95%RH, without condensation water.
- (5) Installed in place of plane fixing vibration smaller than $5.9\text{m/s}^2(0.6\text{g})$.
- (6) Keep away from electromagnetic disturbance source and other electronic apparatus sensible to electromagnetic disturbance.

3.1.2 Installation direction and space

- (1) Normally the inverter should be mounted vertically, horizontal mounting will seriously affect heat dissipation and the inverter must be used in lower volume.
- (2) Demand for minimum mounting space and distance, please see Fig.3-1.
- (3) When install multiple inverters up and down, must apply leading divider between them, see Fig.3-2.

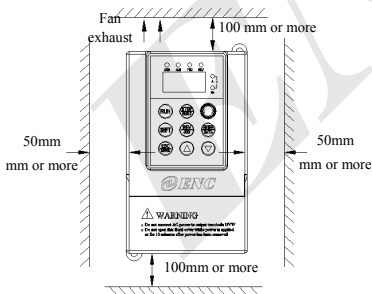

Fig. 3-1 Mounting space

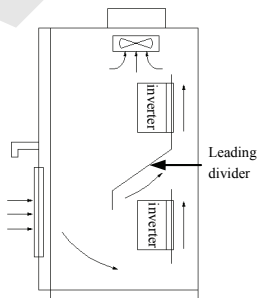

Fig. 3-2 Mounting of multiple inverters

3.2 Parts disassembly and installation

3.2.1 Key board disassembly and installation

(1) Disassembly

Let the forefinger press finger inlet on the keypad, depress fixing flexible plate on the top lightly, draw it outward, then you can disassemble the keypad.

(2) Assembly

First place the fixing hook at the bottom of keypad onto mounting claw on keypad mounting hole, let forefinger press fixing flexible plate on top of keypad and then push it inside, release it in proper location(after a crisp sound).

3.2.2 Plastic cover disassembly

Put the finger into handle hole on the bottom of cover, lift it, then you can disassemble the cover.

3.3 Wiring notice points



- (1) Assure power cut off completely for above 10 minutes before wiring, otherwise have danger of getting electric shock.
- (2) Forbid connecting power wire to output U, V, W of the inverter.
- (3) There is current leakage in the inverter and leak current of middle/high power inverter is bigger than 5mA, for safety reason, inverter and motor must be earthed safely, commonly use 3.5mm² above copper wire as ground wire and ground resistance smaller than 10Ω.
- (4) Before shipment compression resistance test of the inverter is passed, so user should not conduct compression resistance test again.
- (5) Should not assemble electromagnetic contactor and absorbing capacitance or other absorbing device, see Fig.3-3.
- (6) To be convenient to over current protect of input side and power off maintenance inverter should be connected to power supply through relay.
- (7) Connecting wire for relay input and output loop (X1~X8, OC1~OC4, FWD, REV), should use above 0.75mm² glued wire or shielding wire, one shielding layer end hung in the air, the other connected to grounding end(⊕), connecting wire shorter than 20m.



- (1) Before wiring, assure power supply is cut off completely for 10 minutes and all LED indicator light extinguished.
- (2) Before internal wiring, confirm that DC volt. Between main loop end P+ and P- fall down to below DC36V.
- (3) Wiring can only be done by professional person trained and qualified.
- (4) Before electrification, check if voltage grade of the inverter is in line with that of power supply volt., otherwise will cause personnel injured and device damaged.

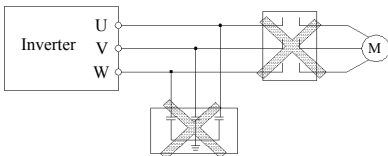

Fig.3-3 Banned magnetic control conductor and absorbing capacitance between inverter and motor

3.4 Main loop terminal wiring

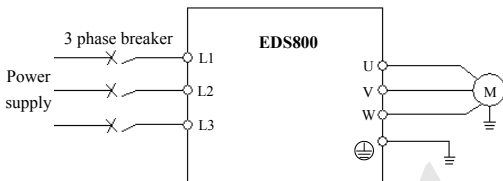

Fig.3-4 Main loop simple wiring

3.4.1 Connection between inverter and fitting parts

(1) Must assemble disjunction device such as isolation switch etc. between powersource and the inverter to assure personal safety when repairing the inverter and needing compulsory power off.

(2) Power supply loop must have breaker or fuse with over current protection function to avoid malfunction expanding caused by failure of after device.

(3) AC input reactor

If high-order harmonics between inverter and Power supply is bigish which can't fulfil system requirement, or need to improve input side power factor, AC input reactor is needed.

(4) Magnetic control conductor only be applied to power supply control and don't apply magnetic control conductor to controlling ON/OFF of the inverter.

(5) Input side EMI filter

Can use EMI filter to inhibit high-frequency conduction disturbance and emission disturbance from inverter power supply wire.

(6) Output side EMI filter

Can use EMI filter to inhibit emission disturbance noise and wire leakage current from output side.

(7) AC output reactor

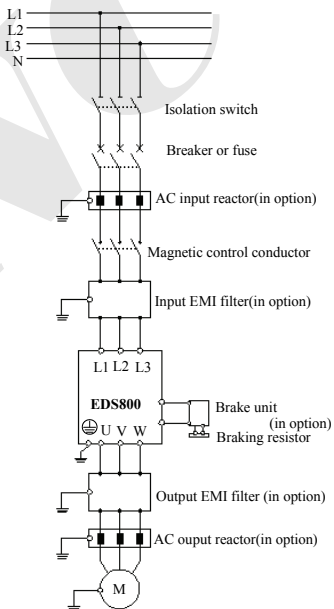

Fig.3-5 Connection of inverter and fitting parts

Advise assembling AC outputreactor to avoid motor insulation damage, too large over current and inverter frequent protection when connecting wire from inverter to motor exceeds 50m. But voltage drop of AC output reactor must be considered. Improve input output voltage of the inverter or let the motor in lower volume to avoid burning off the motor.







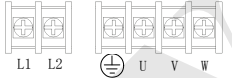

(8) Complete ground wire

Inverter and motor must be earthed and grounding resistor smaller than 10Ω. Grounding wire should be shorter enough and wire diameter be bigger enough(not smaller than 3.5mm²):

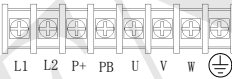
3.4.2 Main loop terminal wiring

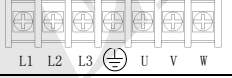
For main loop input output terminal, see table 3-1.

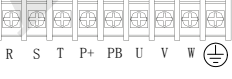
Table 3-1 Main loop input output terminal description

Adapted type	Main loop terminal	End name	Function description
EDS800-2S0002NB ~ EDS800-2S0015NB		L1	Zero wire
		L2	live wire
			Grounding terminal
		U,V,W	3 phase AC output end
EDS800-2S0022N		L1	Zero wire
		L2	live wire
		P+	DC volt. Positive terminal
		PB	External connect to brake resistor reverse terminal
		U,V,W	3 phase AC output end
			Grounding terminal
EDS800-4T0007NB EDS800-4T0015NB		L1,L2,L3	3 phase AC input end
			Grounding terminal
		U,V,W	3 phase AC output end
EDS800-4T0022N EDS800-4T0037N		R,S,T	3 phase AC input end
		P+	DC volt. Positive terminal
		PB	External connect to brake resistor reverse terminal
		U,V,W	3 phase AC output end
			Grounding terminal

3.5 Basic running wiring diagram

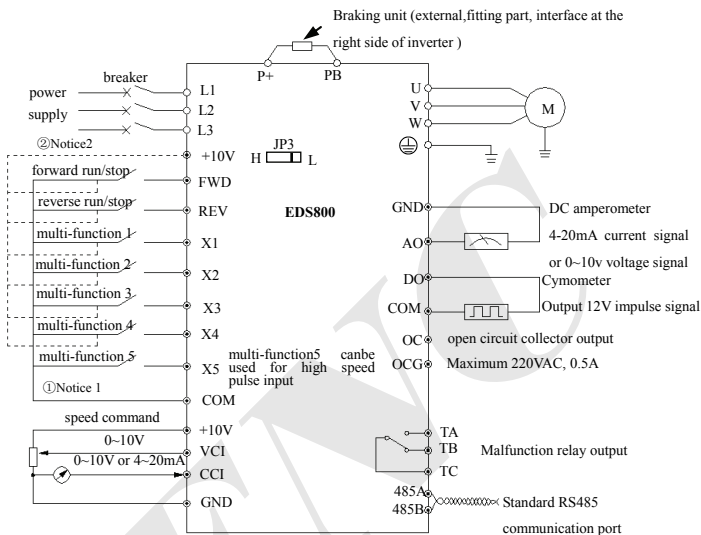

Fig. 3-6 Basic wiring diagram

Notice1: When FWD, REV, X1~X5 terminal input signal need low level (or pup joint with COM) is effective. Please put JP3 on "L".

Notice2: When FWD, REV, X1~X4 terminal input signal need high level (or pup joint with +10v) is effective. Please put JP3 on "H".

3.6 Control loop collocation and wiring

3.6.1 Location & function of terminal and jump-wire:

For location of terminal and switch on the CPU board, please see Fig.3-7.

Function description of terminal provided for the user, please see Table 3-2, function and setup description of switch, please see Table 3-3, terminal CN1 is for manufacturer's use. Should carry on terminal wiring correctly and set switch on the CPU board before using the inverter, to use at least No.24 conducting wire as terminal connecting wire is recommended.

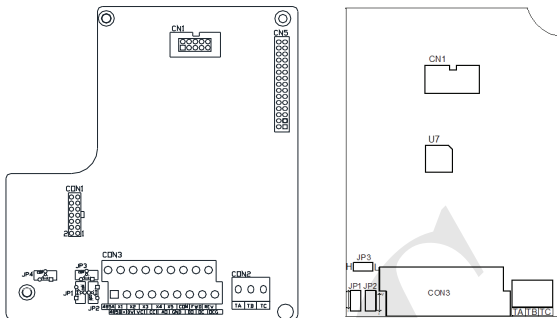

Fig. 3-7 switch on CPU board

Table 3-2 Function description of terminal provided for user

Symbol	Function	Description
CON2	Malfunction relay signal output	Always-open connect pin of the relay closed when malfunction in inverter occurs
CON3	External terminal input output control	Use this port when external terminal control inverter running

Table 3-3 Function description of switch provided for user

Symbol	Function	Factory default
JP1	Analog AO output, 0~10v exchange with 4~20mA When be put on "V" side, for 0~10v output; when be put on "I", for 4~20mA output	0~10V
JP2	Analog CCI input, 0~10V exchange with 4~20mA. When be put on "V" side, for 0~10V input; when be put on "I" side, for 4~20mA input.	0~10V
JP3	Xi terminal input effective level exchange: when put on "H" side, Xi input high level effective (The effective voltage is 5~12V); When put on "L" side, Xi input low level effective (The effective voltage is 0~6V)	Low level effective
JP4	EMI inhibition terminal: When connect to "PE" terminal, it means that connects to grounding. (2.2KW and above types)	suspending

3.6.2 Explanation for control CPU board

(1) Control loop terminal CON3 arranged as follows:

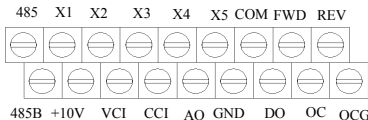

(2) CN2 terminal function description as Table 3-4.

Table 3-4 CPU board CN2 terminal function table

Item	Symbol	Name	Function description	Spec.
Rrun command	FWD	Forward run command	Forward reverse run command, see F5.08 group double-wire and three-wire control function description	Input impedance: R=2K Ω Max. input frequency: 200Hz
	REV	Reverse run command		
Multi-function input terminal	X1	Multi-function input 1	Used for multi-function input terminal, for detailed see Chapter 6 Section 6.6 terminal function parameter (F5 group)input end function description.	X5 can be pule input terminal Max. output Freq.: 50KHz Input voltage range: 12~15V
	X2	Multi-function input 2		
	X3	Multi-function input 3		
	X4	Multi-function input 4		
	X5	Multi-function input 5		
	+10V	+10V power supply	Provide +10V power supply. (Negative pole: GND)	Max. output current: 10mA
	COM	Common end+12V power supply negative pole	12V grounds	
GND	+10V power supply negative pole	Reference ground of analog signal and +10V power supply		
Analog value input	CCI	Analog value input CCI	voltage, current optioned by JP2, factory default is voltage. (Reference ground: GND)	Input voltage range: 0~10V (Input impedance: 70K Ω) Input current range: 4~20mA (Input impedance: 250 Ω) Resolution: 1/1000
	VCI	Analog value input VCI	Accept analog voltage input	Input voltage range: 0~10V (input impedance: 70K Ω) resolution: 1/1000

Analog value output	AO	Analog value output	Provide analog voltage/current Output, can express 6 kinds of parameter see F5.17 parameter description, output voltage/current optioned by JP1, factory default output voltage. (Reference ground: GND)	Current output range: 4~20mA voltage output range: 0~10V
	Multifunction output end	OC	Relay output terminal	Used for multi-function switch output terminal, for detailed see Chapter 6 Section 6.6 terminal function parameter (F5 group) output end function description. (common end: OCG)
		DO	H-speed impulse output terminal	Used for multi-function impulse signal output terminal, for detailed see Chapter 6 Section 6.6 terminal function parameter(F5 group) output end function description. (common end: COM)

(3) RS485 terminal function description as table 3-5

Table 3-5 CPU board RS485 terminal function table

Item	Symbol	Name	Function description	Spec
Communication	485A	485 communication interface	485 difference signal positive end	For standard 485 communication interface please use twisted-pair or STP
	485B		485 difference signal negative end	

(4) Control terminal CON2, arranged as follows:



(5) CON2 terminal function description as Table 3-6.

Table 3-6 CPU board CON2 terminal function

Item	symbol	name	Function description	Spec
Relay output terminal	TA	Inverter malfunction output relay	Normal: TB-TC closed, TA-TC open Malfunction: TB-TC open, TA-TC closed	TB-TC: always-closed, TA-TC: always-open contact capacity: AC250V/2A (COS Φ =1) AC250V/1A (COS Φ =0.4) DC30V/1A
	TB			
	TC			

3.6.3 Analog input output terminal wiring

(1) VCI terminal accepts analog voltage signal input, wiring as follow:

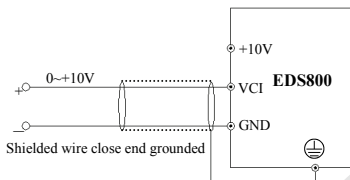

Fig.3-8 VCI terminal wiring diagram

(2) CCI terminal accepts analog signal input, input voltage(0~10V) or input current(4~20mA), wiring mode as follows:

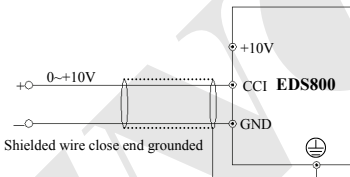

Fig.3-9 CCI terminal wiring diagram

(3) Wiring of analog output terminals AO

Analog output terminals AO connected to analog meter and kinds of physical data can be indicated, terminal wiring mode as Fig.3-10.

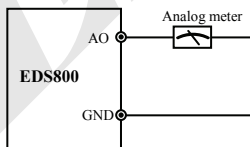

Fig.3-10 Analog output terminal wiring



Note

(1) When inputting analog signal, can connect filter capacitor or common mode inductance between VCI and GND or between CCI and GND.

(2) Analog input, output signal is easy to be disturbed, so must use shielded cable when wiring and well grounded, wiring length should be as short as possible.

3.6.4 Communication terminal wiring

EDS800 inverter provides 485 serial communication interface for the user.

Following wiring methods make single-main single-sub control system or single-main multi-sub control system possible. Using upper machine(PC or PLC controller)software can realize real time supervision to inverter in the industrial control system so that realize complicated run control such as long-distance control,

High automatization etc; you can also take one inverter as mainframe and the others as submachine to form cascade or synchronous control network.

(1) When inverter 485 interface connected to other devices with 485 interface, you can connect wire as below figure.

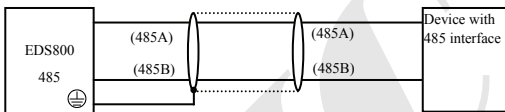

Fig.3-11 Communication terminal wiring

(2) To connect remote control keypad, you can connect plug of remote control keypad to RS485 directly. No need to set any parameter, inverter local keypad and remote control keypad can work at one time.

(3) Connection between inverter RS485 interface and upper machine(with RS232 interface):

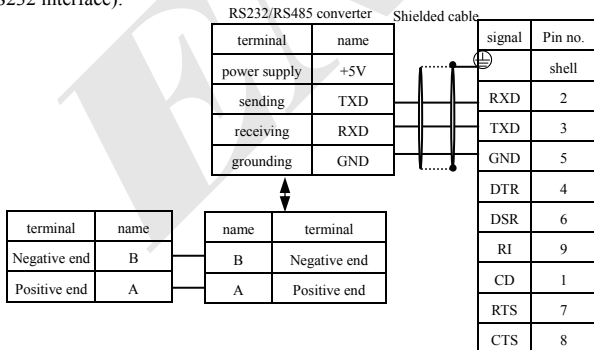

Fig. 3-12 RS485 communication wiring

(4) Multiple inverters can be connected together per RS485 and 31pcs inverter can be connected together at most. Communication system is more prone to disturbance as connected inverters increasing, following wiring is recommended:

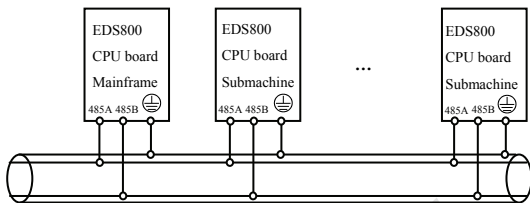

Fig. 3-13 recommended wiring for multiple inverters communication
(All inverters and motors well earthed)

Normal communication still not available if using above wiring, can try to take following measure:

- 1> Provide separate power supply for PLC (or upper machine) or isolate its power supply.
- 2> Apply magnetic circle on the communication wire.
- 3> Reduce inverter carrier wave frequency properly.



Note

- (1) When form the network only by inverters, you must set local address parameter F2.15 of the mainframe EDS800 to 0.
- (2) For programming of RS485 interface, please refer to chapter 10 MODBUS communication protocol.

3.7 Installation guide for anti-jamming

Main circuit of the inverter is composed of high-power semiconductor switch gear, so some electromagnetic noise will arise during work, to reduce or stop disturbance to environment, show you assembling method of inverter disturbance suppressing from many aspects such as disturbance suppressing, spot wiring, system grounding, leak current, usage of power supply filter etc. in this section to be referred to during spot assembling.

3.7.1 Restraining to noise disturbance

Disturbance brought by the working inverter may affect nearby electronic device, effect degree relates to surrounding electromagnetic environment of the inverter and anti-disturbance capacity of this device.

(1) Type of disturbance noise

According to work principle of the inverter, there are mainly 3 kinds of noise disturbance source:

- 1> Circuit conduction disturbance;
- 2> Space emission disturbance;
- 3> Electromagnetic induction disturbance;

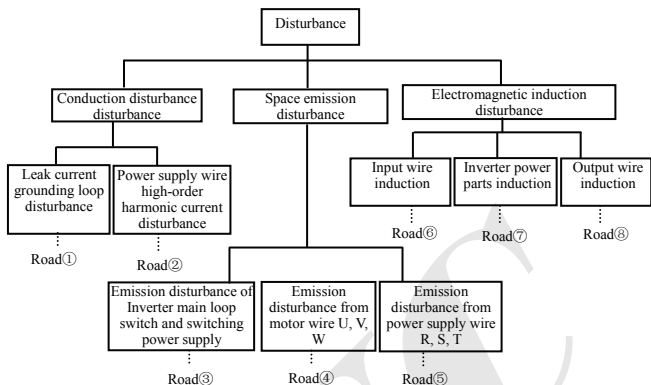

Fig.3-14 Type of noise disturbance

(2) Noise spread road

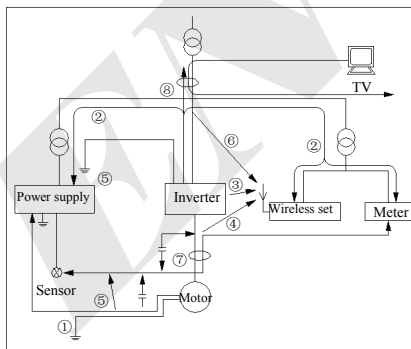

Fig.3-15 Noise disturbance spread road sketch

(3) Basic countermeasure for suppressing disturbance

Table 3-7 Disturbance suppressing countermeasure table

Noise spread road	Countermeasure of weakening effect
①	When grounding wire of peripheral device and wiring of the inverter compose closed-loop, inverter grounding wire leakage current would make the device do wrong

	action. Can reduce wrong action if the device is not earthed here.
②	High-order harmonic from the inverter would make voltage and current transmit through power supply wire when peripheral device and the inverter electrified by same power supply, would disturb other devices in this same power supply system, can take following suppressing measure: assemble electromagnetic noise filter at inverter input end; isolate other devices by isolation transformer; connect power supply for peripheral device with remote power source; install ferrite filter magnetic circle for L1, L2, L3 three-phase conducting wire of the inverter to suppress conduction of high-frequency harmonic current.
③④⑤	<ul style="list-style-type: none"> ● Keep device and signal wire prone to disturbance from the inverter. Should use shielded signal wire, shielding layer single end earthed and try best to keep away from the inverter and its input, output wire. If signal wire must intersect strong power cable, must keep them in real intersection and avoid parallel. ● Install high-frequency noise filter (ferrite common module choke, folksay magnetic circle) separately at input, output root, which can effectively suppress emission disturbance from dynamic wire. ● Should place motor cable shield of biggish thickness, for instance set it in tube with biggish thickness (above 2mm) or bury it in cement slot. Dynamic wire set into metal tube and use shielding wire to be grounded (use 4-core motor cable, one side is earthed through the inverter, the other side connected to motor shell).
⑥⑦⑧	To prevent parallel or bundled power and weak conducting wire; should keep away from inverter mounted device to the best and its wiring should keep away from power wire of the inverter such as L1, L2, L3, U, V, W etc.. Should pay attention to relative mounting place between device with strong electric field or strong magnetic field and the inverter, should keep distance and vertical intersection.

3.7.2 Local wiring and earthing

(1) Avoid parallel cable from inverter to motor (U, V, W terminal education wire) and power supply wire (L1, L2, L3 terminal input wire). Should keep distance of 30cm above.

(2) Try your best to place motor table from U, V, W terminals in metal tube or metal wiring slot.

(3) Should use shielded cable as common control signal cable, shielding layer close-to-inverter side earthed after connected with \ominus terminal of inverter.

(4) Cable educed from inverter \ominus terminal must be connected directly to earth-plate and can't be connected to ground through grounding wire of other devices.

(5) Powerful cable(L1, L2, L3, U, V, W)should not parallel control signal cable closely, say nothing of being bundled together, must keep distance of 20~60cm above (related to size of powerful current). Should cross each other vertically if intersection, as Fig.3-16.

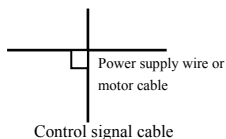

Fig.3-16 System wiring demand

(6) Powerful grounding wire must be connected to earth separately from weak grounding cable such as control signal and sensor cable etc.

(7) Forbid to connect other electricity consumption device to inverter power supply input end (L1, L2, L3).

3.7.3 Relation of long-distance wiring and current leak and the countermeasure

High-order harmonic will form between-line leak current through distributing capacitor and to-earth leak current when long-distance wiring between inverter and motor commence. Can adopt following method to suppress:

- (1) install ferrite magnetic circle or output reactor at inverter output side.



End voltage of the motor will be reduced markedly when installing reactor of 5% above rated voltage drop and make long-distance wiring to U, V, W. Fully loaded motor have the danger of burning itself, should work in lower volume or step up its input output voltage.

- (2) Reduce carrier wave frequency but motor noise would increase accordingly.

3.7.4 Installation demand for electromagnetic on-off electronic device

Relay, magnetic control conductor and electromagnetic iron and so on, these electromagnetic on-off electronic device would bring lots of noise during work, so you should pay full attention to when installing them beside the inverter or in the same control chamber with the inverter and must install surge absorbing device as shown in Fig.3-17.

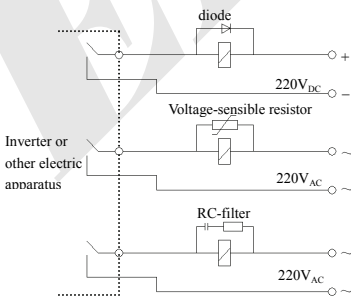

Fig.3-17 Installation demand for electromagnetic on-off device

4 Run and operation explanation for inverter

4.1 Run of inverter

4.1.1 Running order channels

There are 3 kinds of order channel for controlling run action of the inverter such as run, stop, jog etc.:

0: Keypad

Control by key , ,  on keypad(factory default).

1: Control terminal

Use control terminal FWD, REV, COM to make of double-line control, or use one terminal of X1~X5 and FWD or REV to make of three-line control.

2: Serial port

Control run and stop of the inverter through upper machine or other device which can communicate with the inverter.

Choose order channel by setting function code F0.02; and also can choose by multi-function input terminal (F5.00~F5.07 choose function 29, 30, 31).



Please make switching debugging in advance when switch the order channel to check if it can fulfil system requirement, otherwise have danger of damaging device and injuring personal.

4.1.2 Frequency-provision channel

Under EDS800 common run mode there are 9 kinds of provision channel:

0: Keypad analog potentiometer provision;

1: Direct digital frequency provision;

2: Terminal UP/DOWN provision(store after power-off or stop);

3: Serial port provision;

4: Analog value VCI provision;

5: Analog value CCI provision;

6: Reserved;

7: Terminal pulse(PULSE) provision;

8: Combination set;

9: Terminal UP/DOWN provision (Not store after power-off or stop)

4.1.3 Work state

Work state of EDS800 is classified as waiting state and running state:

Waiting state: If there is no running command after the inverter electrified or after stop command during running state, the inverter enters into waiting state.

Running state: the inverter enters into running state after receiving run command.

4.1.4 Run mode

EDS800 inverter have 6 kinds of run mode, following is in turn according to their priority: jog run→closed-loop run→PLC run→multisection speed run → traverse run → common run. Shown as Fig.4-1.

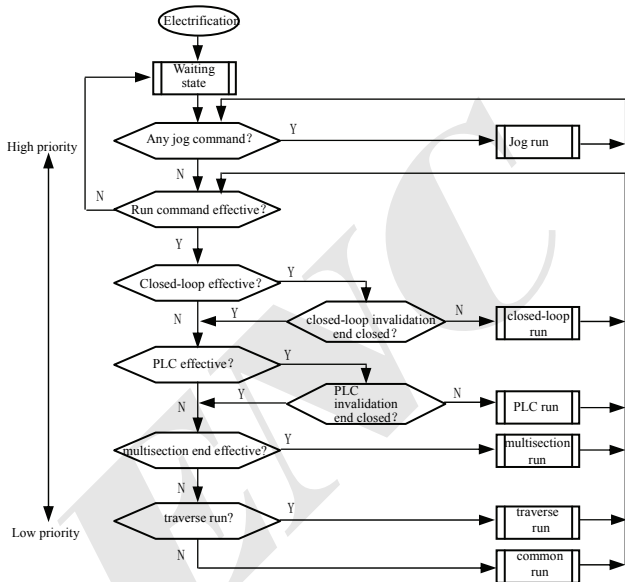



Fig.4-1 Logic flow chart of EDS800 inverter run state

0: Jog run

Upon receiving jog run command (For instance, press the  key on keypad) during waiting state, the inverter run at jog frequency (see function code F2.06~F2.08).

1: Closed-loop run

The inverter will come into closed-loop run mode when closed-loop run control effective parameter is set (F3.00=1). Namely carry on PID adjustment to specified value and feedback value (proportion integral differential calculation, see F3 group function code) and PID adjustor output is inverter output frequency. Can make closed-loop run mode ineffective and switch to lower level run mode by multi-function terminal (function 20).

2: PLC run

The inverter will enter into PLC run mode and run according to run mode preset (See F4 group function code description) through setting PLC function effective parameter(F4.00 last bit \neq 0). Can make PLC run mode ineffective and switch to lower level run mode by multi-function terminal (function 21).

3: Multi-section speed run

By nonzero combination of multi-function terminal(1, 2, 3, 4 function), choose multisection frequency 1~15(F2.30~F2.44) to run at multisection speed.

4: Traverse run

The inverter will enter into traverse run mode when traverse function effective parameter (F6.00=1) is set. Set relevant traverse run special parameter according to textile traverse craft to realize traverse run.

5: Common run

Common open loop run mode of general inverter.

In above 6 kinds of run mode except “jog run” the inverter can run according to kinds of frequency setting method. In “PID run” “PLC run” “multisection run” “common run” mode the inverter can also carry on pendular frequency adjustment.

4.2 Operation and use of key board

4.2.1 Keypad layout

Keypad is main unit for receiving command, displaying parameter. Outer dimension of EN-KB6 is as Fig.4-2:

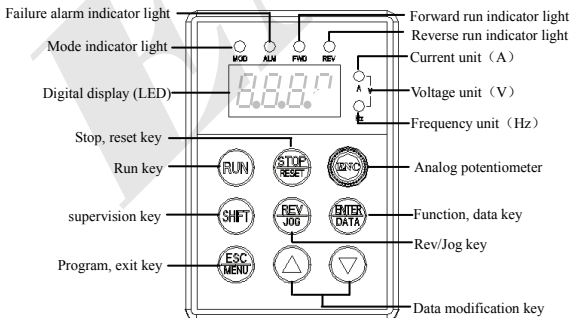











Fig.4-2 Keypad layout sketch (EN-KB5)

4.2.2 Keypad function description

There are 8 key-presses and one adjusting button for analog potentiometer on inverter Keypad and function definition of each key is as shown in table 4-1.

Table 4-1 Keypad function table

Key	Name	Function description
	Program/exit key	Enter into or exit programming state
	Shift/Supervision key	Can choose modification digit of set data under editor state; can switch display status supervision parameter under other state.
	Function/data key	Enter into the next menu or data confirmation
	Rev/Jog key	Under keypad mode, to press this key can set reverse run or Jog run according to the 2nd bit of parameter F0.03
	Run key	Enter into reverse run under keypad mode
	Stop/reset key	In common run status the inverter will be stopped according to set mode after pressing this key if run command channel is set as keypad stop effective mode. The inverter will be reset and resume normal stop status after pressing this key when the inverter is in malfunction status.
	Analog potentiometer	Be used to set frequency; when F0.00=0 value set by analog potentiometer is frequency provision
	Increasing button	To increase data or function code (To press it continuously can improve increasing speed)
	Decreasing button	To decrease data or function code (To press it continuously can improve decreasing speed)

4.2.3 LED and indicator light

4 status indicator light: They are MOD (Mode), ALM (Alarm), FWD (Forward run), REV (Reverse run) from left to right on the LED, their respective indicating meaning is as shown in table 4-2.

Table 4-2 status indicator light description

Item		Function description	
Display function	Digital display	Display current run status parameter and set parameter	
	Status indicator light	A,Hz,V	Unit for relevant current digital displayed physical parameter(for current is A, for voltage is V, for frequency is Hz)
		MOD	This indicator light is lit in nonsupervision status and extinguished if no key pressed for a minute, then come back to supervision status
		ALM	Alarm indicator light, indicate that the inverter is in over current or over voltage suppressing status or failure alarm status currently
	FWD	Forward run indicator light, indicate that the inverter output forward phase order and the connected motor rotate in forward direction	The inverter work in DC brake status if FWD, REV indicator light is lit at the same time

	REV	Reverse run indicator light, indicate that the inverter output reversephase order and the connected motor rotate in reverse direction	
--	-----	---	--

4.2.4 Key board display status

EDS800 keypad display status is classified as waiting status parameter display, function code parameter editing status display, malfunction alarm status display, run status parameter display in total 4 kinds of status. LED indicator light will all be lit after the inverter electrified, and digital display LED will display character“-EN-”, then enter into set frequency display. As shown in Fig.4-3 a.

(1) Waiting parameter display status

The inverter is in waiting status and waiting status supervision parameter is displayed on keyboard, normally parameter F3.28 decide which status supervision parameter to be displayed. As shown in Fig.4-3 b, the unit is indicated by rightward unit indicator light.

To press **SHIFT** key, it can display different waiting status supervision parameter circularly (Display 15 kinds of supervision parameter of C group acquiescently, whether the last 7 kinds of supervision parameter are displayed is defined by function code F2.11, F2.12, for detail please see C group status supervision parameter in function parameter schedule graph of chapter 5).

(2) Run parameter display status

The inverter enters into run status when receiving effective run command and normally parameter F3.28 decide which status supervision parameter to be displayed on the keypad. As shown in Fig.4-3 c, unit is displayed by rightward unit indicator light.

To press **SHIFT** key, can display run status supervision parameter circularly (Defined by function code F2.11 and F2.12). During displaying, can press **ENTER DATA** to switch to initial supervision parameter decided by F3.28, otherwise will display the last displayed parameter all along.



Fig.a electrification,
display-EN-



Fig.b waiting status,
display waiting
status parameter



Fig.c run status, display
run status parameter

Fig.4-3 Inverter electrification, waiting, run status display

(3) Failure alarm display status

The inverter enters into failure alarm display status upon detecting failure signal and display failure code sparkingly (as shown in Fig.4-4); To press **SHIFT** key can look over relative parameter after stopping running; Can press **ESC MENU** key to enter into program status to see about Fd group parameter if want to search failure information. Can carry on failure restoration by **STOP RESET** key, control terminal or communication command on the keypad after troubleshooting. Keep displaying failure code if failure exist continuously.

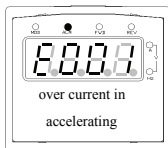

Fig.4-4 Failure alarm



For some serious failure, such as inverse module protect, over current, over voltage etc., must not carry on failure reset forcibly to make the inverter run again without failure elimination confirmed. Otherwise have danger of damaging the inverter!

(4) Function code editing status

Under waiting, run or failure alarm status, press **ESC MENU** key, can enter into editing status (If user password is set, can enter into editing status after inputting the password, see also FF.00 description and Fig.4-10), and editing status is displayed according to three classes menu mode, as shown in Fig. 4-5. To press **ENTER DATA** key can enter into one class by one class. Under function parameter display status, to press **ENTER DATA** key to carry on parameter storage operation; To press **ESC MENU** key can only come back to upper class menu without storing modified parameter.

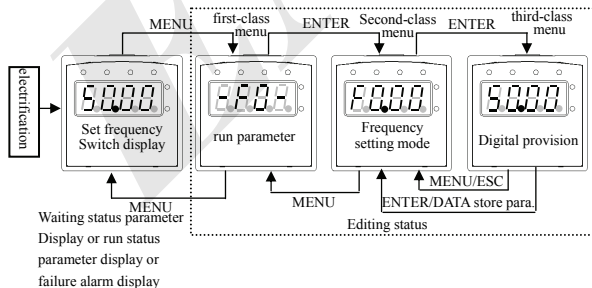

Fig.4-5 Keypad display status switching

(5) Special display function

You can change set frequency under supervision state directly when keypad potentiometer is effective (F0.00=0) or keypad digital setting is effective (F0.00=1). Here the inverter displays set frequency if it's stop or displays output frequency if

it's running. After set frequency stops changing for 1 second the inverter will go back to normal display status.

4.2.5 Method for operating keypad

Can carry on various operation to the inverter through keypad, for example:

(1) Status parameter display switching:

After pressing key **SHIFT**, Display C group status supervision parameter; after displaying one supervision parameter code for 1 second, will display this parameter value automatically.

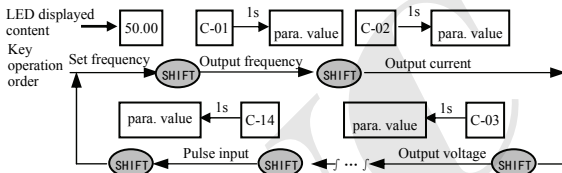

Fig. 4-6 Waiting status parameter display operating example

Description:

1> All status parameters C-00~C-14 can be displayed when the inverter leaves factory. You can make a change by modifying function code F2.11, F2.12 if you want to, for detail please refer to F2.11, F2.12 function code description.

2> Can press **ENTER DATA** key to switch into constant supervision C-01 display status directly when the user see about status supervision parameter.

(2) Function code parameter setting

Take function code F2.06 modified from 5.00Hz to 6.00Hz as example. Boldface in Fig.4-7 shows flickering digit.

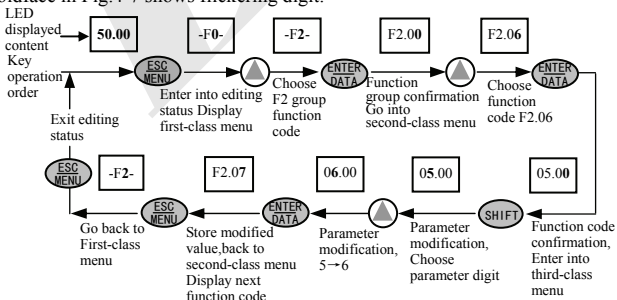

Fig.4-7 Example for parameter setting and modification

Description: under third-class menu, if the parameter has no blinking digit, this function code can't be modified, possible reasons are as follows:

a> This function code shouldn't be modified, for example actual detected status parameter, run record parameter etc.;

b> This function code can't be modified under run status and can be changed after stopping running;

c> Parameter protected. All the function code can't be modified when function code F2.13=1 or 2, in order to avoid wrong operation. Need to set the function code F2.13 to 0 if you want to edit function code parameter.

(3) Specified frequency adjustment for common run

Take example modifying specified frequency from 50.00Hz to 40.00Hz at F0.00=0 during running for explanation.

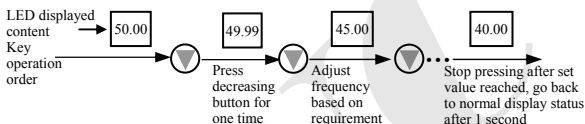

Fig. 4-8 Set frequency adjustment operation example

(4) Jog run operation

For example, keypad as current run command channel, jog run frequency 5Hz, waiting status.

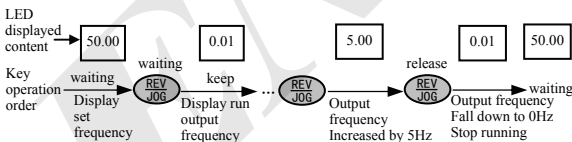

Fig.4-9 Jog run operating example

(5) Operation for entering to function code editing status after setting user password

"user password"FF.00 is set to "6886". Boldfaced digit in Fig.4-7 shows blinking bit.

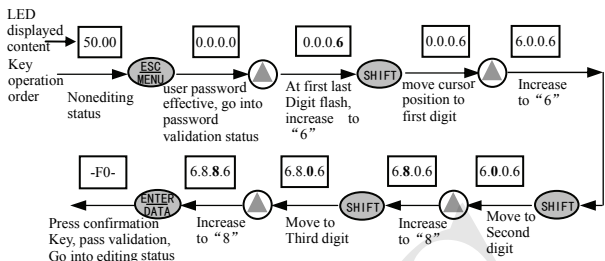

Fig.4-10 Inputting password to go into function code operation

(6) See about failure parameter under failure status

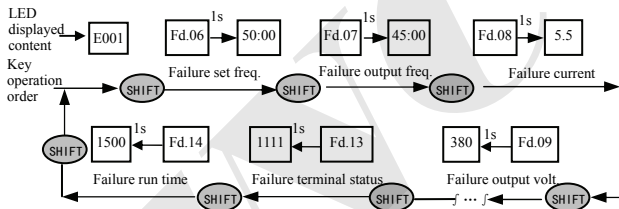

Fig.4-11 Failure status searching operation example

Description:

1> If press **SHIFT** key under failure status the user can see about Fd group function code parameter, search range Fd.06~Fd.14, LED first display function code number when the user press **SHIFT** key and display parameter digit of this function code after 1s.

2> When the user see about failure parameter, can press **ENTER DATA** key directly to switch back to failure alarm display status (E0XX)

(7) Keypad key-press locking operation

Under unlocked keypad situation, press **ESC MENU** key for 5s to lock the keypad. For detailed operation please refer to 2nd bit of F2.13 function code.

(8) Keypad key-press unlocking operation

Under locked keypad situation, press **ESC MENU** key for 5s to unlock the keypad.

4.3 Inverter electrification

4.3.1 Check before electrification

Please carry on wiring based on operation requirement provided in “inverter wiring” of this Service manual.

4.3.2 First electrification

Close input side AC power supply switch after correct wiring and power supply confirmed, electrify the inverter and keypad LED display “-EN -”, contactor closed normally, LED displayed set frequency shows that electrification is finished. First electrification operation process is shown as Fig. 4-12.

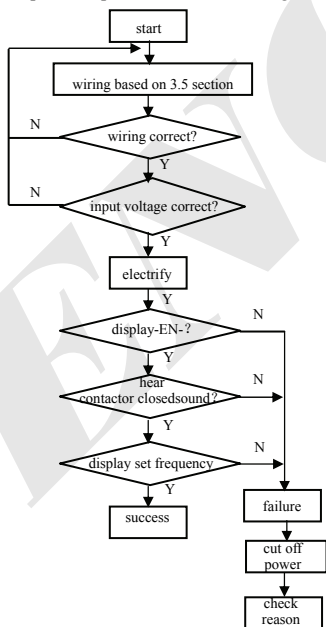

Fig. 4-12 first electrification operation flow

5 Function parameter schedule graph

5.1 Symbol description

- × ---- Parameter can't be changed in process of running
 ○ ---- Parameter can be changed in process of running
 * ---- Read-only parameter, unmodifiable

5.2 Function parameter schedule graph

F0-Basic run function parameter group					
Function code	Name	Set range	Unit	Factory default	Modification
F0.00	Frequency input channel selection	0: Keypad analog potentiometer setting 1: Keypad digital setting 2: Terminal UP/DOWN adjust setting (Stored after power off) 3: Serial port setting 4: VCI analog setting (VCI-GND) 5: CCI analog setting (CCI-GND) 6: Reserved 7: Terminal pulse (PULSE) setting 8: Combination setting 9: Terminal UP/DOWN adjust setting (Not stored after power off) 10: Provision serial port (stored after power off) 11: Terminal PWM pulse setting freq.	1	1	○
F0.01	Freq. digit setting	Lower limit Freq.~ upper limit Freq.	0.01Hz	50.00Hz	○
F0.02	Run command channel selection	0: Keypad run control 1: Terminal run command control (Keypad stop command ineffective) 2: Terminal run command control (Keypad stop command effective) 3: Serial port run command control (Keypad stop command ineffective) 4: Serial port run command control (Keypad stop command effective)	1	0	○
F0.03	Run direction setting	Units digit: 0: Forward run 1: Reverse run Tens digit: 0: Reverse run allowed 1: Reverse run banned Hundreds digit: REV/JOG key selection 0: As reverse run key 1: As jog key	1	100	○
F0.04	Acce/Dece mode selection	0: linear accelerating decelerating mode 1: S curve accelerating decelerating mode	1	0	×
F0.05	S curve start section time	10.0(%) - 50.0(%) (Acce/Dece time) F0.05+F0.06 ≤ 90 (%)	0.1(%)	20.0(%)	○
F0.06	S curve risetime	10.0(%) - 70.0(%) (Acce/Dece time)	0.1(%)	60.0(%)	○



EDS800 series Service Manual

F0.05+F0.06≤90(%)					
F0.07	Accelerating decelerating time unit	0: Second 1: Minute	1	0	×
F0.08	Acce time 1	0.1 - 6000.0	0.1	20.0	○
F0.09	Dece time 1	0.1 - 6000.0	0.1	20.0	○
F0.10	Upper limit freq.	Lower limit freq. - 400.00Hz	0.01Hz	50.00Hz	×
F0.11	Lower limit freq.	0.00 - Upper limit freq.	0.01Hz	0.00Hz	×
F0.12	Lower limit freq. run mode	0: Run at lower limit freq. 1: Stop running	1	0	×
F0.13	Torque boost mode	0: Manual boost 1: Automatic boost	1	0	○
F0.14	Torque boost	0.0 - 20.0(%)	0.1(%)	4.0(%)	○
F0.15	V/F curve setting	0: Constant torque curve 1: Degressive torque curve 1 (The 2.0nd power) 2: Degressive torque curve 2 (The 1.7th power) 3: Degressive torque curve 3 (The 1.2th power) 4: End-user sets VF curve himself (Determined by F2.37~F2.44) F2.37 VF Freq. value 0 F2.38 VF voltage value 0 F2.39 VF Freq. value 1 F2.40 VF voltage value 1 F2.41 VF Freq. value 2 F2.42 VF voltage value 2 F2.43 VF Freq. value 3 F2.44 VF voltage value 3 Remark: VF frequency and voltage can't be 0 or maximum	1 0.01Hz 0.01% 0.01Hz 0.01% 0.01Hz 0.01% 0.01Hz 0.01% 0.01Hz 0.01%	0.50Hz 2.00% 20.00Hz 38.00% 25.00Hz 48.00% 40.00Hz 80.00%	×
F0.16	Reserved				

F1- Start-up, stop, brake function parameter group

Function code	Name	Set range	Unit	Factory default	Modifi-cation
F1.00	Start-up run mode	0: Start at start-up freq. 1: First brake, then start at start-up freq. 2: Reserved	1	0	×
F1.01	Start-up freq.	0.0 ~10.00Hz	0.01Hz	0.00Hz	○
F1.02	Start-up freq. duration	0.0~ 20.0s	0.1s	0.0s	○
F1.03	Zero freq. DC braking volt.	0 ~15 (%)	1	0	○
F1.04	Zero freq. DC braking time	0.0 ~20.0S	0.1s	0.0s	○
F1.05	Stop mode	0: Dec stop 1: Free stop 2: Dec +DC brake stop	1	0	×
F1.06	DC brake initiative freq. when stop running	0.0 -15.00Hz	0.01Hz	0.00Hz	○
F1.07	DC brake time when stop running	0.0~20.0s	0.1s	0.0s	○
F1.08	DC brake voltage when stop running	0~15(%)	1	0	○

F2 -Auxiliary run function parameter group					
Function code	Name	Set range	Unit	Factory default	Modification
F2.00	Analog filter time constant	0.00 ~30.00s	0.01s	0.20s	○
F2.01	Forward reverse run dead-section time	0.0 ~3600.0s	0.1s	0.1s	○
F2.02	Automatic energy save run	0: No action 1: Action	1	0	×
F2.03	AVR function	0: No action 1: Action all the time 2: No action only during Dec	1	0	×
F2.04	Slip frequency compensation	0~150(%)0-no slip frequency compensation	1	0	×
F2.05	Carrier wave freq.	2~15.0K	0.1K	Depend on machine type	×
F2.06	Jog run frequency	0.10~50.00Hz	0.01Hz	5.00Hz	○
F2.07	Jog Acc time	0.1~60.0s	0.1s	20.0s	○
F2.08	Jog Dec time	0.1~60.0s	0.1s	20.0s	○
F2.09	Frequency input channel combination	0: VCI+CCI 1: VCI-CCI 2~5: Reserved 6: Exterior pulse provision+CCI 7: Exterior pulse provision-CCI 8~12: Reserved 13: VCI, CCI any nonzero value effective, VCI preferred 14: Reserved 15: RS485+CCI 16: RS485-CCI 17: RS485+VCI 18: RS485-VCI 19: RS485+Keypad potentiometer 20: RS485- Keypad potentiometer 21: VCI+ Keypad potentiometer 22: VCI- Keypad potentiometer 23: CCI+ Keypad potentiometer 24: CCI- Keypad potentiometer 25: VCI*QWG(keypad potentiometer) 26~28: Reserved	1	0	×
F2.10	Principal subordinate Machine communication frequency provision proportion	0(%) ~500(%)	1(%)	100(%)	○
F2.11	LED display control 1	0000~1111 Units digit: Running time 0: Not display 1: Display Tens digit: Accumulative time 0: Not display	1	1111	○

		<p>1: Display Hundreds digit: Input terminal status 0: Not display 1: Display Thousands digit: Output terminal status 0: Not display 1: Display</p>			
F2.12	LED display control 2	<p>0000~1111 Units digit: Analog input VCI 0: Not display 1: Display Tens digit: Analog input CCI 0: Not display 1: Display Hundreds digit: Reserved Thousands digit: Exterior pulse input 0: Not display 1: Display</p>	1	1111	○
F2.13	Parameter operation control	<p>Units digit: 0: All parameter allowed to be modified 1: Except this parameter, all other parameter not allowed to be modified 2: Except F0.01 and this parameter, all other parameter not allowed to be modified Tens digit: 0: No action 1: Restore default value 2: Clear history failure record Hundreds digit(After setting, It will be valid after pressing MENU key for 5 seconds and entering into Locc status): 0: lock all buttons 1: lock all buttons but not STOP key 2: lock all buttons but not  , STOP key 3: lock all buttons but not RUN, STOP key 4: lock all buttons but not SHIFT, STOP key</p>	1	000	×
F2.14	Communication configuration	<p>Units digit: Baud rate selection 0: 1200BPS 1: 2400BPS 2: 4800BPS 3: 9600BPS 4: 19200BPS 5: 38400BPS Tens digit: Data format 0: 1-8-1 format, No checkout 1: 1-8-1 format, Even checkout 2: 1-8-1 format, Odd checkout Hundreds digit: Response selection 0: Respond to host command and reply to</p>	1	0003	×

		data packet 1:Respond to host command, but not reply Thousand digit: Protocol selection 0:Modbus protocol 1:Free protocol			
F2.15	Local address	0~127, 0 is broadcast address..	1	1	×
F2.16	Communication overtime	0.0~1000.0s, 0 means communication timeout detection invalid.	0.1s	0.0s	×
F2.17	Local responson delay	0~200ms	1ms	5ms	×
F2.18	Acce time 2	0.1~6000.0	0.1	20.0	○
F2.19	Dece time 2	0.1~6000.0	0.1	20.0	○
F2.20	Acce time 3	0.1~6000.0	0.1	20.0	○
F2.21	Dece time 3	0.1~6000.0	0.1	20.0	○
F2.22	Acce time 4	0.1~6000.0	0.1	20.0	○
F2.23	Dece time 4	0.1~6000.0	0.1	20.0	○
F2.24	Acce time 5	0.1~6000.0	0.1	20.0	○
F2.25	Dece time 5	0.1~6000.0	0.1	20.0	○
F2.26	Acce time 6	0.1~6000.0	0.1	20.0	○
F2.27	Dece time 6	0.1~6000.0	0.1	20.0	○
F2.28	Acce time 7	0.1~6000.0	0.1	20.0	○
F2.29	Dece time 7	0.1~6000.0	0.1	20.0	○
F2.30	Multisection freq. 1	Lower limit freq.~ upper limit freq.	0.01Hz	5.00Hz	○
F2.31	Multisection freq. 2	Lower limit freq.~ upper limit freq.	0.01Hz	10.00Hz	○
F2.32	Multisection freq. 3	Lower limit freq.~ upper limit freq.	0.01Hz	20.00Hz	○
F2.33	Multisection freq. 4	Lower limit freq.~ upper limit freq.	0.01Hz	30.00Hz	○
F2.34	Multisection freq. 5	Lower limit freq.~ upper limit freq.	0.01Hz	40.00Hz	○
F2.35	Multisection freq. 6	Lower limit freq.~ upper limit freq.	0.01Hz	45.00Hz	○
F2.36	Multisection freq. 7	Lower limit freq.~ upper limit freq.	0.01Hz	50.00Hz	○
F2.37	Multisection freq. 8	Lower limit freq.~ upper limit freq.	0.01Hz	5.00Hz	○
	VF frequency value 0	0.00~F2.39	0.01Hz	0.50Hz	○
F2.38	Multisection freq. 9	Lower limit freq.~ upper limit freq.	0.01Hz	10.00Hz	○
	VF voltage value 0	0.00~F2.40	0.01%	2.00%	○
F2.39	Multisection freq. 10	Lower limit freq.~ upper limit freq.	0.01Hz	20.00Hz	○
	VF frequency value 1	F2.37~F2.41	0.01Hz	20.00Hz	○
F2.40	Multisection freq. 11	Lower limit freq.~ upper limit freq.	0.01Hz	30.00Hz	○
	VF voltage value 1	F2.38~F2.42	0.01%	38.00%	○
F2.41	Multisection freq. 12	Lower limit freq.~ upper limit freq.	0.01Hz	40.00Hz	○
	VF frequency value 2	F2.39~F2.43	0.01Hz	25.00Hz	○
F2.42	Multisection freq. 13	Lower limit freq.~ upper limit freq.	0.01Hz	45.00Hz	○
	VF voltage value 2	F2.40~F2.44	0.01%	48.00%	○
F2.43	Multisection freq. 14	Lower limit freq.~upper limit freq.	0.01Hz	50.00Hz	○
	VF frequency value 3	F2.41~high limit frquency	0.01Hz	40.00Hz	○
F2.44	Multisection freq. 15	Lower limit freq.~ upper limit freq.	0.01Hz	50.00Hz	○
	VF voltage value 3	F2.42 ~100.0% (rated voltage)	0.01%	80.00%	○
F2.45	Jumping freq. 1	0.00~400.00Hz	0.01Hz	0.00Hz	×
F2.46	Jumping freq. 1 range	0.00~30.00Hz	0.01Hz	0.00Hz	×
F2.47	Jumping freq. 2	0.00~400.00Hz	0.01Hz	0.00Hz	×
F2.48	Jumping freq. 2 range	0.00~30.00Hz	0.01Hz	0.00Hz	×

F2.49	Jumping freq. 3	0.00~400.00Hz	0.01Hz	0.00Hz	×
F2.50	Jumping freq. 3 range	0.00~30.00Hz	0.01Hz	0.00Hz	×
F2.51	Setting run time	0~65535 hours	1	0	○
F2.52	Accumulative run time	0~65535 hours	1	0	*
F2.53	Encryption time	0~65535 hours	1	0	○

F3 group –Closed-loop run function parameter group

Function code	Name	Set range	Unit	Factory default	Modification
F3.00	Closed-loop run control selection	0: Closed-loop control ineffective 1: PID closed-loop control effective 2: Constant pressure water supply PID control specialized (One tows one)	1	0	×
F3.01	Provision channel selection	0: Digital provision 1: VCI analog 0~10V voltage provision 2: CCI analog provision 3: Keypad potentiometer provision	1	0	○
F3.02	Feedback channel selection	0: VCI analog input voltage 0~10V 1: CCI analog input 2: VCI+CCI 3: VCI-CCI 4: Min { VCI, CCI } 5: Max { VCI, CCI } 6: Pulse feedback	1	0	○
F3.03	Specified value digital setting	0.000~9.999V(SetF3.00=1,F3.21=9.999)	0.001	0.200	○
	Target pressure value setting	0.000~F3.21Mpa (SetF3.00=2)	0.001	0.200	○
F3.04	Minimum specified value	0.0~Maximum specified value; percentage relative to 10.00V	0.1(%)	0.0(%)	○
F3.05	Feedback value responding to minimum specified value	0.0~100.0(%)	0.1(%)	0.0(%)	○
F3.06	Maximum specified value	Minimum specified value~100.0(%)	0.1(%)	100.0(%)	○
F3.07	Feedback value responding to maximum specified value	0.0~100.0(%)	0.1(%)	100.0(%)	○
F3.08	Proportion gain Kp	0.000~9.999	0.001	0.150	○
F3.09	Integral gain Ki	0.000~9.999	0.001	0.150	○
F3.10	Differential gain Kd	0.000~9.999	0.001	0.000	○
F3.11	Sampling cycle T	0.01~1.00s	0.01s	0.10s	○
F3.12	Deviation margin	0.0~20.0% Relative to the percentage of set value.	0.1(%)	2.0(%)	○
F3.13	Integral separation PID adjusting threshold	0.0~100.0%	0.1(%)	100.0(%)	○
F3.14	Closed-loop preset frequency	0~upper limit frequency	0.01Hz	0.00Hz	○

F3.15	Closed-loop preset frequency holding time	0.0~6000s	0.1s	0.0s	○
F3.16	Sleep frequency threshold	0.00~400.00Hz	0.01Hz	0.01Hz	○
F3.17	Revival frequency threshold	0.00~400.00Hz	0.01Hz	0.01Hz	○
F3.18	Sleep delay time	0.0~6000.0s	0.1s	0.0s	○
F3.19	Revival delay time	0.0~6000.0s	0.1s	0.0s	○
F3.20	Reserved				
F3.21	Long-distance pressure meter range	0.001~9.999Mpa	0.001	1.000	○
F3.22 ~ F3.25	Reserved				
F3.26	Water supply supervision parameter display	0: C-11, C-12 denote voltage value of VCI, CCI 1: C-11, C-12 denote PID specified pressure and feedback pressure	1	0	○
F3.27	Closed-loop adjusting characteristic	0: Forward function 1: Reverse function		0	○
F3.28	LED initial supervision parameter selection	0: Set frequency 1: Output frequency 2: Output current 3: Output voltage 4: DC bus bar voltage 5: Motor speed 6: Heat sink temperature 7: Run time 8: Accumulative run time 9: Input terminal status 10: Output terminal status 11: Analog input VCI/PID provision 12: Analog input CCI/PID feedback 13: Analog input YCI 14: Exterior pulse inputs		1	○
F3.29	YCI run-in delay time	0.0~9.999s	0.1s	0.0s	○
F3.30	Failure relay TA, TB, TC function selection	0: Inverter running(RUN) 1: Frequency arriving signal(FAR) 2: Frequency level detect signal (FDT1) 3: Reserved 4: Overload warning alarm signal (OL) 5: Output frequency reach high limit(FHL) 6: Output frequency reach low limit(FLL) 7: Inverter under voltage blockage stop (LU) 8: External failure stop-running(EXT) 9: Inverter zero speed running 10: PLC running 11: Simple PLC section running finished 12: PLC finish a cycle running 13: Reserved 14: Inverter ready to run (RDY)		15	○

		15: Inverter failure 16: Traverse high and low limit restriction 17: Interior counter reach final value 18: Interior counter reach specified value 19: Set run time arriving 20: Interior timing arriving 21: Reserved 22:FWD running 23: REV running 24: Reserved			
F3.31	Reserved				

F4-Simple PLC function parameter group

Function code	Name	Set range	Unit	Factory default	Modification
F4.00	Simple PLC running setting	Units digit: 0: No action 1: Stop after single circulation 2: Keep final value after single circulation 3: Consecutive circulation Tens digit: 0: Start again from first section 1: Continue to run at mid-section frequency 2: Continue to run from operation frequency of interruption moment Hundreds digit: PLC run time unit 0: Second 1: Minute Thousands digit: PLC running state power off treatment method 0: Power off no memory 1: Running with memory when power off, renew running after power on (Terminal control exceptional) 2: Running with memory when power off, automatic running after power on	1	0000	×
F4.01	Section 1 setting	000~621 Units digit: Frequency setting 0: Multisection freq. i (i=1~7) 1: Freq.determined by F0.00 function code Tens digit: Run direction selection 0: Forward run 1: Reverse run 2: determined by run command Hundreds digit: Acc/Dec time selection 0: Acc/Dec time 1 1: Acc/Dec time 2 2: Acc/Dec time 3 3: Acc/Dec time 4 4: Acc/Dec time 5 5: Acc/Dec time 6	1	000	○

		6: Acc/Dec time 7			
F4.02	Section 1 run time	0~6000.0	0.1	10.0	○
F4.03	Section 2 setting	000~621	1	000	○
F4.04	Section 2 run time	0~6000.0	0.1	10.0	○
F4.05	Section 3 setting	000~621	1	000	○
F4.06	Section 3 run time	0~6000.0	0.1	10.0	○
F4.07	Section 4 setting	000~621	1	000	○
F4.08	Section 4 run time	0~6000.0	0.1	10.0	○
F4.09	Section 5 setting	000~621	1	000	○
F4.10	Section 5 run time	0~6000.0	0.1	10.0	○
F4.11	Section 6 setting	000~621	1	000	○
F4.12	Section 6 run time	0~6000.0	0.1	10.0	○
F4.13	Section 7 setting	000~621	1	000	○
F4.14	Section 7 run time	0~6000.0	0.1	10.0	○

F5 –Terminal correlative function parameter group

Function code	Name	Set range	Unit	Factory default	Modification
F5.00	Input terminal X1 function selection	0: Leave control terminal unused 1: Multisection speed control terminal 2: Multisection speed control terminal 3: Multisection speed control terminal 4: Multisection speed control terminal 5: External forward run jog control 6: External reverse run jog control 7: Acc/Dec time option terminal 1 8: Acc/Dec time option terminal 2 9: Acc/Dec time option terminal 3 10: External device failure input 11: External reset input 12: Free stop input 13: External stop-running order 14: Stop DC braking input command DB 15: Inverter run banned 16: Frequency increasing control (UP) 17: Frequency degression control (DOWN) 18: Acc/Dec ban command 19: Three-line run control 20: Closed-loop ineffective 21: PLC ineffective 22: Simple PLC pause control 23: PLC stop status reset 24: Frequency provision channel option 1 25: Frequency provision channel option 2 26: Frequency provision channel option 3 27: Frequency switched to CCI 28: Command switched to terminal 29: Run command channel option 1 30: Run command channel option 2 31: Run command channel option 3 32: Traverse jump-in	1	0	×

		33: External interruption input 34: Interior counter reset end 35: Interior counter triggering end 36: Interior timer reset end 37: Interior timer triggering end 38: Pulse frequency input (Only effective for X5) 39: Pulse width frequency input (only for X5) 40-42: Reserved			
F5.01	Input terminal X2 function selection	Same as above			×
F5.02	Input terminal X3 function selection	Same as above			×
F5.03	Input terminal X4 function selection	Same as above			×
F5.04	Input terminal X5 function selection	Same as above			×
F5.05	Reserved				
F5.06	Reserved				
F5.07	Reserved				
F5.08	FWD/REV run mode selection	0: Double-line control mode 1 1: Double-line control mode 2 2: Three-line control mode 1 3: Three-line control mode 2	1	0	×
F5.09	UP/DOWN velocity	0.01~99.99Hz/s	0.01 Hz/s	1.00Hz/s	○
F5.10	Open circuit collector output terminal OC output setting	0: Inverter running(RUN) 1: Frequency arriving signal(FAR) 2: Frequency level detect signal (FDT1) 3: Reserved 4: Overload warning alarm signal (OL) 5: Output frequency reach high limit(FHL) 6: Output frequency reach low limit(FLL) 7: Inverter under voltage blockage stop (LU) 8: External failure stop-runnin(EXT) 9: Inverter zero rotate speed running 10: PLC running 11: Simple PLC section running finished 12: PLC finish a cycle running 13: Reserved 14: inverter ready to run (RDY) 15: inverter failure 16: traverse high and low limit restriction 17: interior counter reach final value 18: interior counter reach specified value 19: set run time arriving 20: interior timing arriving 21: reserved 22:FWD running 23: REV running 24: reserved	1	0	×

F5.11	Reserved				
F5.12	Reserved				
F5.13	Reserved				
F5.14	Frequency arriving (FAR) checkout scope	0.00~50.00Hz	0.01Hz	5.00Hz	○
F5.15	FDT1 (frequency level) electric level	0.00~high limit frequency	0.01Hz	10.00Hz	○
F5.16	FDT1 lag	0.00~50.00Hz	0.01Hz	1.00Hz	○
F5.17	Analog output (AO1) selection	0: Output frequency(0-high limit frequency) 1: Set frequency(0-high limit frequency) 2: Output current(0-2×rated current) 3: Output voltage(0-1.2×load motor rated voltage) 4: Bus-bar voltage(0-800V) 5: PID provision (0.00-10.00V) 6: PID feedback (0.00-10.00V) 7~9: Reserved	1	0	○
F5.18	Analog output (AO) gain	0.00~2.00	0.01	1.00	○
F5.19	Analog output (AO) offset	0.00~10.00V	0.01	0.00	○
F5.20	Reserved				
F5.21	Reserved				
F5.22	Reserved				
F5.23	DO terminal output function selection	Same as F5.17	1	0	○
F5.24	DO maximum pulse output frequency	0.1~20.0(Max. 20KHz) Max. DO port output pulse frequency corresponds to Max. value selected by F5.23	0.1 KHz	10.0	○
F5.25	Set interior counting value reaches provision	0~9999	1	0	○
F5.26	Specified interior counting value reaches provision	0~9999	1	0	○
F5.27	Interior timer setting	0.1~6000.0s	0.1	60.0	○

F6 – Traverse special function parameter group

Function code	Name	Set range	Unit	Factory default	Modification
F6.00	Traverse function selection	0: Traverse function not used 1: Traverse function used	1	0	×
F6.01	Traverse run mode	LED Units digit: Jump-in mode 0: Automatic jump-in mode 1: Terminal manual jump-in mode LED Tens digit: 0: Changing traverse amplitude 1: Fixed traverse amplitude LED Hundreds digit: Traverse halt start mode selection 0: Restart 1: Restart according to halt record LED Thousands digit: Traverse status save selection 0: No save	1	0000	×

		1:Save Notice: Traverse center frequency input channel set by F0.00 function parameter			
F6.02	Traverse amplitude threshold	0.0~50.0(%)	0.1(%)	0.0(%)	○
F6.03	Sudden jumping frequency	0.0~50.0(%)	0.1(%)	0.0(%)	○
F6.04	Traverse cycle	0.1~999.9s	0.1s	10.0s	○
F6.05	Triangle wave risetime	0.0~98(%) (traverse cycle)	0.1(%)	50.0(%)	○
F6.06	traverse preset frequency	0.00~400.00Hz	0.01Hz	0.00Hz	○
F6.07	traverse preset frequency latency time	0.0~6000s	0.1s	0.0s	○

F7-Frequency provision function parameter group

Function code	Name	Set range	Unit	Factory default	Modification
F7.00	VCI min. provision	0.00~F7.02	0.01V	0.00V	○
F7.01	VCI min. provision corresponding freq.	0.00~high limit frequency	0.01Hz	0.00Hz	○
F7.02	VCI max. provision	0.00~10.00V	0.01V	10.00V	○
F7.03	VCI max. provision corresponding freq.	0.00~high limit frequency	0.01 Hz	50.00Hz	○
F7.04	CCI min. provision	0.00~F7.06	0.01V	0.00V	○
F7.05	CCI min. provision corresponding freq.	0.00~high limit frequency	0.01 Hz	0.00Hz	○
F7.06	CCI max. provision	0.00~10.00V	0.01V	10.00V	○
F7.07	CCI max. provision corresponding freq.	0.00~high limit frequency	0.01 Hz	50.00Hz	○
F7.08	Max. Input pulse width	0.1~999.9ms (WhenF0.00=11)	0.1ms	100.0ms	○
F7.09	Min. provision pulse width	0.0~F7.11(Max.provision pulse) (WhenF0.00=11)	0.1ms	0.0ms	○
F7.10	Min. provision corresponding freq.	0.00~high limit frequency	0.01Hz	0.00Hz	○
F7.11	Max. provision pulse width	F7.09 (Min.provision pulse) ~F7.08 (Max.input pulse)	0.1ms	100.0ms	○
F7.12	Max. provision corresponding freq.	0.00~High limit frequency	0.01Hz	50.00Hz	○
F7.13	PULSE max. input pulse	0.1~20.0K	0.1K	10.0K	○
F7.14	PULSE min. provision	0.0~F7.16 (PULSE max. provision)	0.1K	0.0K	○
F7.15	PULSE min. provision corresponding freq.	0.00~High limit frequency	0.01 Hz	0.00 Hz	○
F7.16	PULSE max. provision	F7.14 (PULSE min. provision) ~F7.13 (max. input pulse)	0.1K	10.0K	○
F7.17	PULSE max. provision corresponding freq.	0.00~High limit frequency	0.01 Hz	50.00Hz	○

F8-motor and vector control parameter group

Function code	Name	Set range	Unit	Factory default	Modification
F8.00	Reserved				
F8.01	Motor rated voltage	1~999V	1V	Depend on device type	×
F8.02	Motor rated current	0.1~999.9A	0.1A	Depend on device type	×
F8.03	Motor rated frequency	1.00~400.00Hz	0.01Hz	Depend on device type	×
F8.04	Motor rated speed	1~9999r/min	1r/min	Depend on device type	×

F8.05	Motor pole	2~14	2	Depend on device type	×
F8.06	Motor rated power	0.1~999.9KW	0.1	Depend on device type	×
F8.07 ~ F8.17	Reserved				

F9 –Protection correlative function parameter group

Function code	Name	Set range	Unit	Factory default	Modification
F9.00	Reserved				
F9.00	Instantaneous power off restarting latency time	0.0~10.0S 0 Indicates ineffective power off restarting Remark: No automatic reset function for overload and overheating	0.1S	0.0S	×
F9.01	Failure self-renew times	0~10 0 shows no automatic reset function Remark: no automatic reset function for overload and overheating	1	0	×
F9.02	Failure self-renew interval	0.5~20.0S	0.1S	5.0S	×
F9.03	Motor overload protection mode selection	0: No action 1: Inverter close off output	1	1	×
F9.04	Motor overload protection coefficient	20.0~120.0(%)	0.1(%)	100.0(%)	×
F9.05	Overload warning alarm checkout level	20~200(%)	1(%)	130(%)	○
F9.06	Overload warning alarmDelay time	0.0~20.0s	0.1s	5.0s	○
F9.07	Overvoltage stall selection	0: Ban 1: Allow	1	1	×
F9.08	Overvoltage stall point	120~150(%)	1(%)	140(%)	○
F9.09	Automatic current limit level	110~200(%)	1(%)	150(%)	×
F9.10	Frequency declining rate during current limiting	0.00~99.99Hz/s	0.01Hz/s	10.00Hz/s	○
F9.11	Automatic current limiting action selection	Units digit: 0: Constant speed ineffective 1: Constant speed effective Tens digit: Input loss phase detection 0:Invalid 1:Valid remark: Acc/Dec always effective	1	00	×

Fd –failure record function parameter group

Function code	Name	Set range	Unit	Factory default	Modification
Fd.00	Previous one time failure record	Previous one time failure record	1	0	*
Fd.01	Previous two time failure record	Previous two time failure record	1	0	*
Fd.02	Previous three time failure record	Previous three time failure record	1	0	*
Fd.03	Previous four time failure record	Previous four time failure record	1	0	*
Fd.04	Previous five time failure record	Previous five time failure record	1	0	*
Fd.05	Previous six time failure record	Previous six time failure record	1	0	*

EDS800 series Service Manual

Fd.06	Set freq. of previous failure	Set freq. of previous failure	0.01Hz	0	*
Fd.07	output freq. of previous failure	Output freq. of previous failure	0.01Hz	0	*
Fd.08	output current of previous failure	Output current of previous failure	0.1A	0	*
Fd.09	output voltage of previous failure	Output voltage of previous failure	1V	0	*
Fd.10	DC bus-bar voltage of previous failure	DC bus-bar voltage of previous failure	1V	0	*
Fd.11	Load motor speed of previous failure	Load motor speed of previous failure	1(r/m)	0	*
Fd.12	Module temperature of previous failure	Module temperature of previous failure	1°C	0	*
Fd.13	Input terminal status of previous failure	Input terminal status of previous failure		0	*
Fd.14	Accumulative run time of previous failure	Accumulative run time of previous failure		0	*

FF –Password and manufacturer function parameter group

Function code	Name	Set range	Unit	Factory default	Modification
FF.00	User password	0000~9999	1	0000	×
FF.01	Manufacturer password	0000~9999	1	0000	×
FF.02	Manufacturer's special parameter				
FF.0X					

C –supervision function parameter group

Function code	Name	Set range	Unit	Factory default	Modification
C-00	Set frequency	Current set frequency	0.01HZ		
C-01	Output freq.	Current output freq.	0.01HZ		*
C-02	Output current	Virtual value of current output current	0.1A		*
C-03	Output voltage	Virtual value of current output voltage	1V		*
C-04	DC bus-bar voltage	Current DC bus-bar voltage	1V		*
C-05	Load motor speed	Product of output frequency and load motor speed emendation factor	1(r/m)		*
C-06	Module temperature	IGBT heat sink temperature	1°C		*
C-07	Run time	Inverter electrification run time	1h		*
C-08	accumulative run time	Inverter accumulative run time	1h		*
C-09	Input terminal status	Switch value input terminal status	---		*
C-10	output terminal status	Switch value output terminal status	---		*
C-11	Analog input VCI	Analog input value of VCI	V		*
C-12	Analog input YCI	Analog input value of YCI	V		*
C-13	Reserved				
C-14	Exterior pulse input	Exterior pulse input	0.1KHz		*

(1) Input terminal status corresponding relation is as follows:

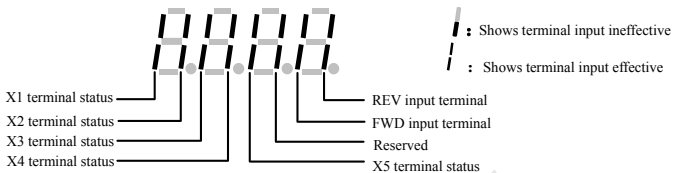

(2) Output terminal status corresponding relation is as follows:

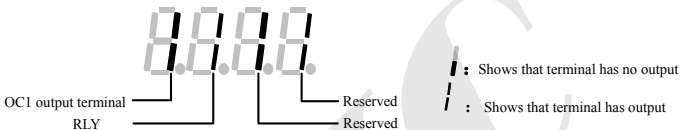

6 Detailed function description



Listed column content for parameter function code description in this chapter is as follows:

Code	Name	Set range or description	Factory default
------	------	--------------------------	-----------------

6.1 Basic run function parameter group: F0

F0.00	Frequency input channel selection	Range: 0~11	1
-------	-----------------------------------	-------------	---

0: Keypad analog potentiometer. Set running frequency by keypad analog potentiometer.

1: Keypad frequency number setting. Initial set frequency value is F0.01, can change set frequency by changing F0.01 parameter through keypad, and you can also modify F0.01 by   key.

2: Terminal UP/DOWN adjust set frequency (stored after power off or stop). Initial set frequency value is the value stored during the last power off time, and you can adjust set running frequency by terminal UP/DOWN.

3: Serial port provision. Serial port frequency set initial value is F0.01, change set frequency by setting F0.01 through serial port.

4: VCI analog setting (VCI-GND). Frequency setting determined by VCI terminal analog voltage, input voltage range: DC 0~10V.

5: CCI analog setting (CCI-GND). Frequency setting determined by CCI terminal analog voltage/current, input range: DC 0~10 (CCI switch choose V side), DC: 4~20mA (CCI switch choose A side).

6: Reserved.

7: Terminal pulse (PULSE) setting. Frequency set by terminal pulse (only input through X5, see F5.03, F5.04 definition), input pulse signal spec: voltage range 15~24V; frequency range 0~20.0KHz.

8: Combination setting. See function parameter F2.09, set frequency by each channel combination setting.

9: Terminal UP/DOWN adjust set frequency (Not stored after power off or stop) Initial set frequency value is F0.01, and adjust set running frequency by terminal UP/DOWN.

10: Serial port specified (Memory after electric off): when the inverter is disconnected with electric, it will keep the currently running frequency, and next time it will keep the former frequency running the electric on.

11: Terminal PWM pulse set frequency.





Note

Relation between frequency and input information is determined by function code F7.00~F7.17 when frequency input channel is 4, 5, 6, 7, please see Section 6.8.

F0.01	Freq. digital setting	Range: low limit ~High limit	1
--------------	------------------------------	-------------------------------------	----------

F0.01 parameter is original set frequency of the inverter when frequency setting channel is defined as number setting (F0.00=1, 3).

F0.02	Run command channel selection	Range: 0 ~4	0
--------------	--------------------------------------	--------------------	----------

0: Keypad run frequency command channel. Start and stop the inverter by , ,  key on the keypad.

1: Terminal run command channel (Keypad STOP command ineffective). Start and stop the inverter by exterior control terminal FWD, REV, X1~X5 etc..

2: Terminal run command channel (Keypad STOP command effective). Start and stop the inverter by exterior control terminal FWD, REV, X1~X5 etc..

3: Serial port run command channel (Keypad STOP command ineffective). Start and stop the inverter by RS485 interface.

4: Serial port run command channel (Keypad STOP command effective). Start and stop the inverter by RS485 interface.



The inverter can change run command channel by modifying F0.02 during waiting and running, please confirm that modification is allowed during running on the spot.

F0.03	Run direction setting	Range: Units digit :0, 1 Tens digit: 0, 1 Hundreds digit: 0, 1	100
--------------	------------------------------	---	------------

This function is only effective for keypad and serial port run command channel ineffective for terminal run command channel.

The Units digit:

0: Inverter forward run

1: Inverter reverse run

The Tens digit:

0: Reverse run allowed

1: Reverse run banned. The inverter will stop output when there is reverse run command.

The Hundreds digit: **REV/JOG key selection**

0: As REV key

1: As JOG key



Note

If the 2nd bit is set to "1", This function is effective for keypad run command channel, terminal run command channel and serial port run command channel.

F0.04	Accelerating decelerating mode selection	Range: 0, 1	0
--------------	---	--------------------	----------

0: Linear Acce/Dece mode. Output frequency increases or decreases according to constant slope, just as shown in Fig.6-1.

1: S curve Acce/Dece mode. Output frequency increases or decreases according to S curve, just as shown in Fig.6-2.

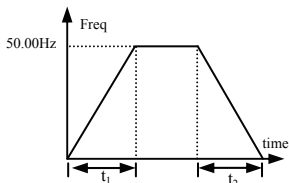

Fig.6-1 Linear Acce/Dece

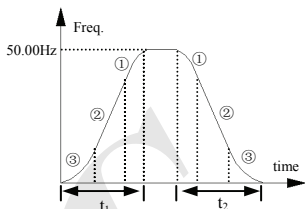

Fig.6-2 S curve Acce/Dece

F0.05	S curve starting time	Range: 10.0(%)~50.0(%) (Acc/Dec time) $F0.05 + F0.06 \leq 90(\%)$	20.0(%)
F0.06	S curve rising time	Range: 10.0(%)~80.0(%) (Acc/Dec time) $F0.05 + F0.06 \leq 90(\%)$	60.0(%)

F0.05, F0.06 is only effective when S curve Acc/Dec mode(F0.04 = 1) is selected during Acc/Dec selection, and $F0.05 + F0.06 \leq 90\%$.

S curve starting time is shown as Fig. 6-2③, slope of output frequency variation increases by degrees from 0.

S curve rising time is shown as Fig.6-2②, slope of output frequency variation is constant.

S curve ending time is shown as Fig.6-2①, slope of output frequency variation steps down to 0.



Note

S curve Acc/Dec mode, suitable for starting and stopping elevator, deferent belt, carrier transporter load etc..

F0.07	Acc/Dec time unit	Range: 0, 1	0
-------	-------------------	-------------	---

This function determines Acc/Dec time unit.

0: Second

1: Minute



Note

(1) This function is effective for all Acc/Dec process except for jog run.

(2) To choose second as time unit is recommended.

F0.08	Acc time 1	Range: 0.1~6000.0	20.0
F0.09	Dec time 1	Range: 0.1~6000.0	20.0

Accelerating time is defined as time for inverter accelerating from 0Hz to high limit frequency, see t_1 in Fig.6-3, Dec time is defined as time for inverter decelerating from high limit frequency to 0Hz, see t_2 in Fig.6-3.

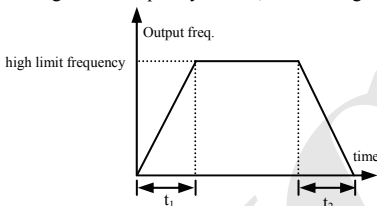

Fig.6-3 Acc/Dec time definition

(1) In EDS800 series inverter 7 kinds of Acc/Dec time are defined in total, here we only define Acc/Dec time 1, Acc/Dec time 2~7 are defined in F2.18~F2.29, please refer to Section 6.3.



(2) Can choose time unit minute or second for Acc/Dec time 1~7 by F0.07, factory default is second.

F0.10	high limit frequency	Range: low limit~400.00Hz	50.00Hz
F0.11	low limit frequency	Range: 0.00~high limit	0.00Hz
F0.12	Low limit freq. run mode	Range: 0: Run at low limit freq. 1: Stop running	0

The inverter will decrease output frequency gradually in set decelerating time when actual set frequency is lower than low limit frequency, after reaching low limit frequency, the inverter will run at low limit frequency if F0.18 is set to 0; The inverter will reduce output frequency sequentially to zero frequency run if F0.12 is set to 1.

F0.13	Torque boost mode	Range: 0: manual 1: automatic	0
--------------	--------------------------	--------------------------------------	----------

0: Manual boost. Torque boost voltage is determined completely by parameter F0.14, its characteristic is boost voltage fixed, but the motor is prone to magnetic saturation when lightly loaded.

1: Automatic torque boost. Torque boost voltage varies as stator current of the motor changes, bigger stator boost current corresponds to bigger boost voltage.

$$\text{Boost volt.} = \frac{F0.14}{100} \times \text{Motor rated volt.} \times \frac{\text{Inverter output current}}{2 \times \text{Inverter rated current}}$$

F0.14	Torque boost	Range: 0.0~20.0(%)	4.0(%)
--------------	---------------------	---------------------------	---------------

To improve inverter's low frequency torque characteristic, can carry on boost compensation for output voltage, degressive torque curve and constant torque curve and constant torque curve torque boost are separately shown as Fig.6-4 (a), (b).

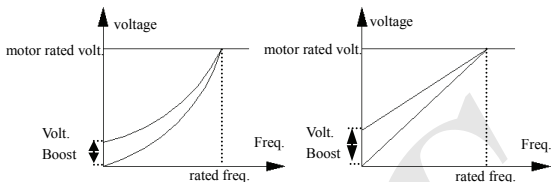

(a) Degressive torque curve torque boost graph (b) Constant torque curve torque boost graph

Fig.6-4 Torque boost graph



Note

Improper setting to this parameter can cause motor heating or over current protection.

F0.15	V/F curve setting	Range: 0~4	0
--------------	--------------------------	-------------------	----------

This function code defines EDS800 flexible V/F setting mode to satisfy different load characteristic. Can choose 4 kinds of fixed curve according to definition of F0.15.

If F0.15=0, V/F curve bears constant torque characteristic; as curve 0 in Fig.6-5.

If F0.15=1, V/F curve bears 2.0 order power degressive torque characteristic; as curve 3 in Fig.6-5.

If F0.15=2, V/F curve bears 1.7 order power degressive torque characteristic; as curve 2 in Fig.6-5.

If F0.15=3, V/F curve bears 1.2 order power degressive torque characteristic; as curve 1 in Fig.6-5.

The user can choose 1, 2, 3 V/F curve run mode according to load characteristic to reach better energy save result while the inverter is driving degressive torque load such as blower and water pump etc.

If F0.15=4, you can set V/F curve yourself by setting F2.37-F2.44 parameters.

As shown in Fig.6-5b, by setting three inflexion point (V1,F1), (V2,F2), (V3,F3), you can define V/F curve arbitrarily to apply to special load.

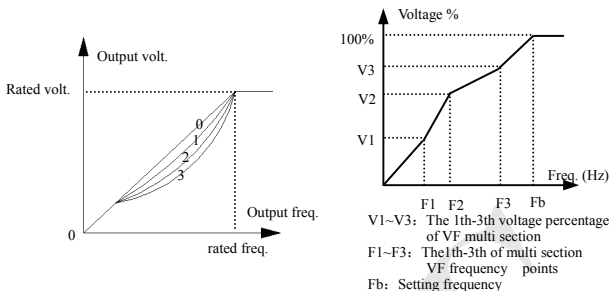

F0.16	Reserved		
--------------	----------	--	--

6.2 Start-up, stop, braking function parameter group: F1

F1.00	Start-up run mode	Range: 0, 1, 2	0
--------------	-------------------	----------------	---

0: Start from starting frequency. The inverter start according to F1.01 starting frequency and F1.02 starting frequency holding time.

1: First braking then starting. First brake according to DC braking voltage and time (F1.03, F1.04), then start at starting frequency.

2: Reserved.



Note

(1) Start-up mode 0: Advise the user to adopt start-up mode 0 in common application occasion and when driving synchronous motor.

(2) Start-up mode 1: Be applicable to small inertia load with forward run or reverse run phenomena when the motor doesn't drive any device, for big inertia load, advise not to adopt start-up mode 1.

F1.01	Starting frequency	Range: 0.0~10.00Hz	0.00 Hz
F1.02	Starting freq. holding time	Range: 0.0~20.0s	0.0s

Starting frequency means initial frequency at which the inverter start up, as shown in Fig.6-6; Starting freq. holding time means consecutive run time during which the inverter run at starting frequency, as t1 shown in Fig.6-6.

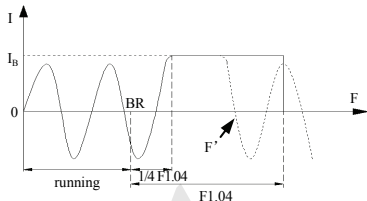
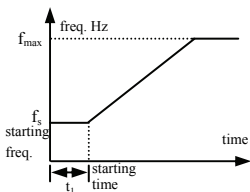

Fig.6-6 Starting freq. and starting time

Fig.6-7 Zero freq. DC braking Volt. And Time



Note

Starting frequency is not limited by low limit frequency.

F1.03	Zero freq. DC braking volt.	Range: 0~15(%)	0(%)
F1.04	Zero freq. DC braking time	Range: 0.0~20.0s	0.0s

Zero Freq. DC braking is special function for FKM (Flat Knitting Machine). Specific function is: the inverter enters into braking status automatically during running when running frequency is lower than F3.29 (Zero Freq. Braking frequency), and realizes continuance of current phase intelligently, fast and smooth orientation for motor's rotor. The inverter will stop braking automatically and switch into running if specified frequency increased or reverse running instruction provided in the braking, Curve figure as Fig 6-7:

(1) I_B is zero Freq. braking current, to set according to actual braking torque by setting F1.03.

(2) BR is specified zero Freq. braking signal point, inverter enters into zero Freq. braking status automatically after 1/4 F1.04.

(3) F' is any time in braking. When specified frequency increased or reverse running instruction provided, the inverter will end zero Freq. braking and enter into running status. But the inverter is still in running status and waits for frequency raising instruction.

(4) After F1.04, the inverter stops output and the motor is in zero Freq. running status if there is neither frequency raising instruction nor reverse instruction.

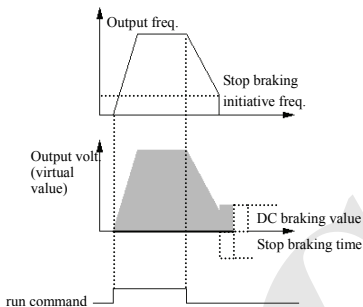

Fig.6-8 Dec stop+DC braking

F1.05	Stop mode	Range: 0, 1, 2	0
--------------	------------------	-----------------------	----------

0: Dec stop. The inverter reduces output frequency gradually according to set Dec time upon receipt of stop command and stops running after frequency is reduced to 0.

1: Free stop. The inverter stops outputting at once when receiving stop command and the load stops freely according to mechanical inertia.

2: Dec plus DC braking stop. The inverter reduces output frequency gradually according to set Dec time upon receipt of stop command and starts DC braking when F1.06 stop braking initiative frequency is reached.

F1.06	Stop DC braking initiative frequency	Range: 0.0~15.00Hz	0.00Hz
F1.07	Stop DC braking time	Range: 0.0~20.0S	0.0S
F1.08	Stop DC braking voltage	Range: 0~15(%)	0

F1.08 is percentage relative to inverter rated input voltage. Have no DC braking process if stop braking time is 0.0s, as shown in Fig.6-8.

6.3 Auxiliary run function parameter group: F2

F2.00	Analog filtering time constant	Range: 0.00~30.00S	0.20S
--------------	---------------------------------------	---------------------------	--------------

The time constant used when the inverter filter sampled value when frequency is set by exterior analog channel. Can improve the situation by increasing this filtering time constant if connecting wire is long or disturbance is serious which cause unstable set frequency.

Analog filtering time constant must be bigger than F3.11(sampling cycle), otherwise the system would run unsteadily.

F2.01	FWD REV run dead-section time	Range: 0.0~3600.0s	0.1s
--------------	--------------------------------------	---------------------------	-------------

During process of transiting from forward run to reverse run or from reverse run to forward run, transition time during which the inverter wait at zero output frequency, as t_1 shown in Fig.6-9.

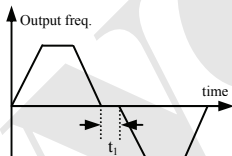

Fig.6-9 FWD REV run dead-section time

F2.02	Automatic energy save run	Range: 0, 1	0
--------------	----------------------------------	--------------------	----------

To reach better energy save result, the inverter would detect load current to get the purpose of automatic energy save.

0: No action

1: Action

Empty or lightly loaded motor can get the purpose of energy save by detecting load current to adjust output voltage properly. Automatic energy save run is mainly applied to occasion of stable load, speed.



Note

This function commonly applied to load such as blower and water pump etc.

F2.03	AVR function	Range: 0, 1, 2	0
--------------	---------------------	-----------------------	----------

AVR namely automatic voltage adjusting function. Indicate that the inverter can output constant voltage by AVR function when the inverter input voltage fluctuates.

0: No action

1: Action all the time

2: No action only during Dec



(1) When input voltage is higher than rated value, under normal situation should set F2.03=1. When F1.05=0 namely inverter in decelerating stop, motor Dec time is short and running current would be bigger. But the motor decrease speed placidly with small run current and long Dec time if choose AVR action all the time.

(2) Should set F2.03=0, namely AVR function ineffective when the motor system oscillates which caused by choosing AVR function.

F2.04	Slip freq. compensation	Range: 0~150(%)	0
--------------	--------------------------------	------------------------	----------

This function can adjust output frequency properly as the load varies to compensate slip frequency of the asynchronous motor dynamically, so that control motor speed in constant value. If act with automatic torque boost function, can get better low speed moment characteristic. As shown in Fig.6-10.

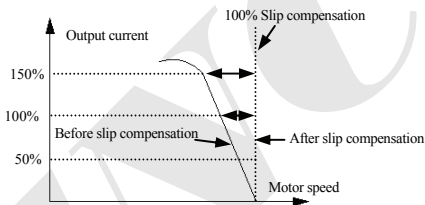

Fig.6-10 Slip freq. compensation graph

F2.05	Carrier freq.	Range: 2~15.0K	Depend on device type
--------------	----------------------	-----------------------	------------------------------

Carrier frequency mainly affects motor noise and heat consumption during running. Relation between carrier frequency and motor noise, current leakage, disturbance is as follows:

Carrier frequency increase(↑), motor noise decrease(↓), motor current leakage increase(↑), disturbance to environment increase(↑);

Carrier frequency decrease (↓), motor noise increase (↑), motor current leakage decrease (↓), disturbance to environment decrease (↓).

Should decrease carrier frequency properly to reduce heat consumption of the inverter when ambient temperature is high and motor load is heavy. Relation of EDS800 each type and carrier frequency is as shown in Table 6-1.

Table 6-1 Relation table of device type and carrier frequency

Carrier freq. Device type	Max. carrier freq. (KHz)	Min. carrier freq (KHz)	Factory default (KHz)
0.2KW	15	2.0	2
0.4KW	15	2.0	2

0.75KW	14	2.0	2
1.5KW	13	2.0	2
2.2KW	13	2.0	2
3.7KW	13	2.0	2



Note

- (1) To get better control characteristic, suggest that the ratio of carrier frequency to inverter max. run frequency be not smaller than 36.
- (2) Error exists in current displayed value when carrier frequency is small.

F2.06	Jog run frequency	Range: 0.10~50.00Hz	5.00Hz
F2.07	Jog Acc time	Range: 0.1~60.0s	20.0s
F2.08	Jog Dec time	Range: 0.1~60.0s	20.0s

Jog frequency has the highest priority. Under any status, the inverter would transit to run at jog frequency at once according to set jog accelerating, decelerating time as long as jog command is inputted, as shown in Fig.6-11.

Jog accelerating time means time during which the inverter accelerate from 0Hz to high limit frequency, Jog Dec time means time during which the inverter decelerate from high limit frequency to 0Hz.

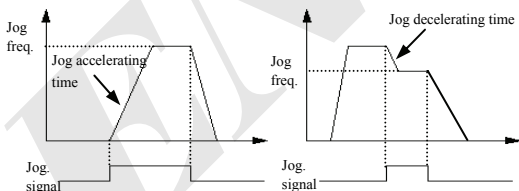

Fig.6-11 jog run



Note

- (1) Keypad, control terminal and serial port can do jog control all.
- (2) The inverter will stop according to Dec stop mode after jog run command is withdrawn.

F2.09	Freq. input channel combination	Range: 0~28	0
-------	---------------------------------	-------------	---

- 0: VCI+CCI
 1: VCI-CCI
 2: Reserved
 3: Reserved
 4: Reserved

- 5: Reserved**
6: External pulse provision + CCI
7: External pulse provision - CCI
8: Reserved
9: Reserved
10: Reserved
11: Reserved
12: Reserved
13: VCI, CCI any nonzero value effective, VCI preferred
14: Reserved
15: 485+CCI
16: 485-CCI
17: 485+VCI
18: 485-VCI
19: 485+ keypad analog potentiometer
20: 485- keypad analog potentiometer
21: VCI+ keypad analog potentiometer
22: VCI- keypad analog potentiometer
23: CCI+ keypad analog potentiometer
24: CCI- keypad analog potentiometer
25: VCI*QWG (Keypad analog potentiometer)
26: Reserved
27: Reserved
28: Reserved

F2.10	Host inverter communication freq. provision proportion	Range: 0~500(%)	100(%)
--------------	---	------------------------	---------------

Host&sub inverter communication freq. provision proportion, This parameter need to be set in sub inverter but not need in host inverter.

F2.11	LED display control 1	Range: 0000~1111	1111
--------------	------------------------------	-------------------------	-------------

F2.11 make use of 4 bits of the parameter to set if C-07—C-10 is displayed in parameter, thereinto 0 indicates not displayed, 1 indicates displayed. Set parameter of 4 bit is as following figure:

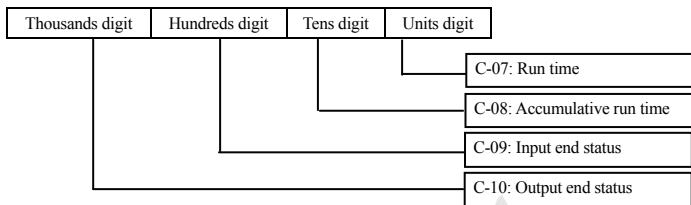

F2.12	LED display control 2	Range: 0000~1111	1111
--------------	------------------------------	-------------------------	-------------

F2.12 make use of 4 bit of the parameter to set if C-11—C-14 is displayed in parameter, thereinto 0 indicates not displayed, 1 indicates displayed. Set parameter of 4 bit is as following figure:

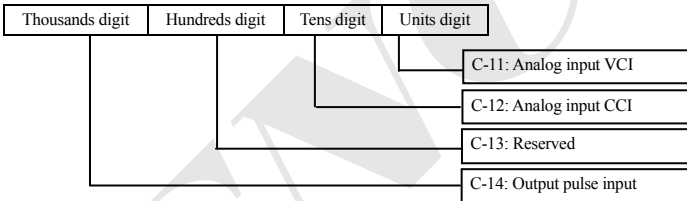

F2.13	Parameter operation control	Range: Units digit: 0~2 Tens digit: 0~2 Hundreds digit: 0~4	000
--------------	------------------------------------	--	------------

Units digit

0: All parameter allowed to be modified

1: Except this parameter, all other parameter not allowed to be changed

2: Except F0.01 and this parameter, all other parameter not allowed to be changed

Tens digit

0: No action

1: Renew factory default

2: Clear history failure record

Hundreds digit (After setting, It will be valid after pressing MENU key for 5 seconds and entering into Locc status)

0: Lock all buttons

1: All the buttons locked except STOP key

2: All the buttons locked except ▲▼, STOP key

- 3: All the buttons locked except RUN, STOP key
 4: All the buttons locked except SHIFT, STOP key



Note

(1) Factory default of this function parameter is 0, i.e., all the function parameter can be modified. After modifying the parameter, please first set this function code to 0 if you want to modify function code setting. After modifying the parameter you can change this function code setting to expected protection grade if parameter protection is needed.

(2) After clearing memory information or renewing manufacturer parameter, the 1st bit of this function code will resume 0 automatically.

(3) After the 3rd bit of F2.13 is setted, the keypad will be locked after you press ESC for 5 seconds, and then corresponding keys is locked. Please press ESC for 5 seconds again for unlocking the keypad.

F2.14	Communication deployment	Range: Units digit: 0~5 Tens digit: 0, 1, 2 Hundreds digit: 0, 1 Thousands digit: 0, 1	0003
-------	--------------------------	---	------

F2.14 make use of 1st bit, 2nd bit, 3rd bit to set baud rate and data format of serial communication, thereinto Units digit represents communication baud rate, set value as follows:

0: 1200BPS

1: 2400BPS

2: 4800BPS

3: 9600BPS

4: 19200BPS

5: 38400BPS

Tens digit: Represents data format, set value as follows:

0: 1—8—1 format, no checkout. Namely: 1 bit for starting, 8 bits for data, 1 bit for stop, no checkout.

1: 1—8—1 format, even checkout. Namely: 1 bit for starting, 8 bits for data, 1 bit for stop, even checkout.

2: 1—8—1 format, odd checkout. Namely: 1 bit for starting, 8 bits for data, 1 bit for stop, odd checkout.

Hundreds digit: Response selection

0: Respond to host command and reply to data packet

1: Respond to host command, but not reply

Thousands digit: Protocol selection

0: Modbus protocol

1: Free protocol

F2.15	Local address	Range: 0~127, 0 is broadcast address	1
-------	---------------	--------------------------------------	---

In serial port communication, the function code is used to identify the address of the inverter. When set to 0, this inverter only receives not send.



0 is broadcast address, can only receive and execute broadcast command from upper machine but not respond to upper machine.

F2.16	Communication overtime checkout time	Range: 0.0~1000.0s, 0 means communication timeout detection invalid	0.0s
--------------	---	--	-------------

When serial port communication fails and its continuous time exceed set value of this function code, the inverter judge it as communication failure.

The inverter would not detect serial port communication signal, namely this function ineffective when set value is 0.

F2.17	Local response delay time	Range: 0~200ms	5ms
--------------	----------------------------------	-----------------------	------------

Local response delay time represents the time within which the inverter serial port receive and execute command from upper device and then respond to upper device, this function is just used for setting this delay time.

F2.18	Accelerating time 2	Range: 0.1~6000.0	20.0
F2.19	Decelerating time 2	Range: 0.1~6000.0	20.0
F2.20	Accelerating time 3	Range: 0.1~6000.0	20.0
F2.21	Decelerating time 3	Range: 0.1~6000.0	20.0
F2.22	Accelerating time 4	Range: 0.1~6000.0	20.0
F2.23	Decelerating time 4	Range: 0.1~6000.0	20.0
F2.24	Accelerating time 5	Range: 0.1~6000.0	20.0
F2.25	Decelerating time 5	Range: 0.1~6000.0	20.0
F2.26	Accelerating time 6	Range: 0.1~6000.0	20.0
F2.27	Decelerating time 6	Range: 0.1~6000.0	20.0
F2.28	Accelerating time 7	Range: 0.1~6000.0	20.0
F2.29	Decelerating time 7	Range: 0.1~6000.0	20.0

Can define 3 kinds of accelerating decelerating time and can choose accelerating decelerating time 1~7 during inverter run process by different combination of control terminal, please see definition for function of accelerating decelerating time terminal in F5.00~F5.07.



Note

Accelerating decelerating time 1 is defined in F0.08 and F0.09.

F2.30	Multi-step freq. 1	Range: Lower limit freq.~upper limit freq.	5.00Hz
F2.31	Multi-step freq. 2	Range: Lower limit freq.~upper limit freq.	10.00Hz
F2.32	Multi-step freq. 3	Range: Lower limit freq.~upper limit freq.	20.00Hz
F2.33	Multi-step freq. 4	Range: Lower limit freq.~upper limit freq.	30.00Hz
F2.34	Multi-step freq. 5	Range: Lower limit freq.~upper limit freq.	40.00Hz
F2.35	Multi-step freq. 6	Range: Lower limit freq.~upper limit freq.	45.00Hz
F2.36	Multi-step freq. 7	Range: Lower limit freq.~upper limit freq.	50.00Hz
F2.37	Multi-step freq. 8	Range: Lower limit freq.~upper limit freq.	5.00Hz
	VF freq. value 0	Range:0.00~F2.39	0.50Hz
F2.38	Multi-step freq. 9	Range: Lower limit freq.~upper limit freq.	10.00Hz
	VF voltage value 0	Range:0.00~F2.40	2.00%
F2.39	Multi-step freq. 10	Range: Lower limit freq.~upper limit freq.	20.00Hz
	VF freq. value 1	Range:F2.37~F2.41	20.00Hz
F2.40	Multi-step freq. 11	Range: Lower limit freq.~upper limit freq.	30.00Hz
	VF voltage value 1	Range:F2.38~F2.42	38.00%
F2.41	Multi-step freq. 12	Range: Lower limit freq.~upper limit freq.	40.00Hz
	VF freq. value 2	Range:F2.39~F2.43	25.00Hz
F2.42	Multi-step freq. 13	Range: Lower limit freq.~upper limit freq.	45.00Hz
	VF voltage value 2	Range:F2.40~F2.44	48.00%
F2.43	Multi-step freq. 14	Range: Lower limit freq.~upper limit freq.	50.00Hz
	VF freq. value 3	Range:F2.41~high limit freq.	40.00Hz
F2.44	Multi-step freq. 15	Range: Lower limit freq.~upper limit freq.	50.00Hz
	VF voltage value 3	Range:F2.42~100.0%(rated voltage)	80.00%

These parameters are compound, two kinds of function can't be used simultaneously, for details please check below:

When $F0.15=4$, F2.37~F2.44 are for V/F curve setting, for detailed function description, please see that for F0.15.

When $F0.15 \neq 4$, F2.37~F2.44 are used for multi-section frequency. Setting mode and function are the same as F2.30.

F2.45	Jumping freq. 1	Range: 0.00~400.00Hz	0.00Hz
F2.46	Jumping freq. 1 range	Range: 0.00~30.00Hz	0.00Hz
F2.47	Jumping freq. 2	Range: 0.00~400.00Hz	0.00Hz

F2.48	Jumping freq. 2 range	Range: 0.00~30.00Hz	0.00Hz
F2.49	Jumping freq. 3	Range: 0.00~400.00Hz	0.00Hz
F2.50	Jumping freq. 3 range	Range: 0.00~30.00Hz	0.00Hz

F2.45~F2.50 function is set for keeping inverter output frequency away from resonance frequency of mechanical load.

Inverter set frequency can jump around some frequency point according to mode shown in Fig.6-12, at most 3 jumping range can be defined.

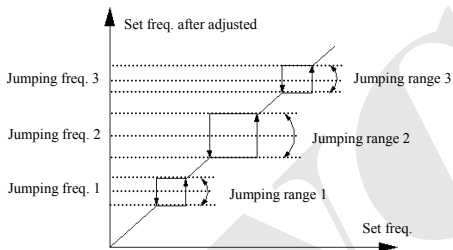

Fig.6-12 Jumping frequency and range graph

F2.51	Set run time	Range: 0~65535h	0
F2.52	Run time accumulation	Range: 0~65535h	0

After run accumulative time reach set run time (F2.51), the inverter will output indicator signal, please refer to F5.10 function introduction.

F2.52 denotes accumulative run time of the inverter from leaving factory to now.

F2.53	Encryption time	Range:0~65535h	0
--------------	------------------------	-----------------------	----------

When F02.53 larger than 1, the encryption time valid. When the accumulated running time (F2.52) exceed time defined by F2.53, the inverter should stop according to stop mode and the keyboard display A-53.The inverter cannot restart until unlocked.

6.4 Closed-loop run control parameter: F3

Analog feedback control system:

Input pressure specified value through VCI port, send 4~20mA feedback value of pressure sensor to inverter CCI input port, make up of analog closed-loop control system by built-in PID adjustor, as shown in Fig.6-13.

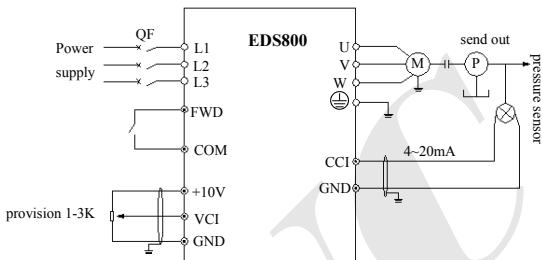

Fig.6-13 Built-in PID analog feedback control system graph



Specified value can also be provided with option by F0.00 function code.

EDS800 built-in PID adjustor make up of control system and its work principle chart is as follows:

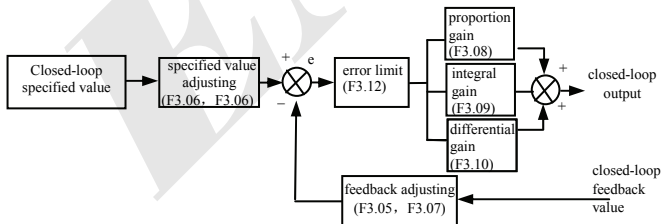

Fig.6-14 PID control principle diagram

In above Fig.6-14, Definition of closed-loop specified value, feedback value, error limit and proportion integral differential parameter is same as that of common PID adjustor parameter, see respectively (F3.01~F3.12) definition, relation of specified value and expected feedback value is as shown in Fig.6-15. Thereinto specified value take 10V as reference and feedback take 20mA as reference.

Specified value adjusting and feedback value adjusting in Fig.6-14 is for

confirming corresponding relation and unitive dimension between specified value and feedback value.

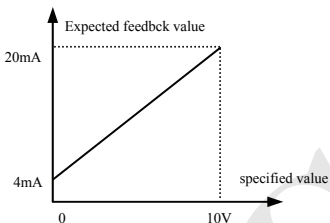

Fig.6-15 Specified value and expected feedback value

When the system is determined, basic steps for setting closed-loop parameter are as follows:

- (1) Determine closed-loop provision and feedback channel (F3.01, F3.02)
- (2) Need to set relation between closed-loop provision and feedback for analog closed-loop (F3.04~F3.07)
- (3) Set closed-loop presetting frequency function (F3.14, F3.15)
- (4) Set closed-loop proportion gain, integral gain, differential gain, sampling cycle, error limit (F3.08~F3.12)

F3.00	Closed-loop run control selection	Range: 0, 1, 2	0
--------------	--	-----------------------	----------

0: Closed-loop run control ineffective

1: PID closed-loop run control effective

2: Constant pressure water supply PID control specialized (one tows one)

F3.00=1, when ordinary PID regulation, the deviation is within deviation limitation, no PID caculation, keep the stable output.

F3.00=2, constant pressure regulation, the deviation is within deviation limitation and running frequency is above the sleep mode frequency, it runs for energy saving, the output frequency descend runnig at 3HZ/Min. When the deviation is within deviation limitation and running frequency is below or equal to sleep mode frequency, after the time of sleep delay, the frequency will go down to 0HZ to run, and the inverter will be sleep mode. When feedback pressure less than revive pressure, afer the time of revive delay, the inverter will run according to PID regulation.

F3.01	Provision channel selection	Range: 0~3	0
--------------	------------------------------------	-------------------	----------

0: Digital provision.

1: VCI analog 0~10V voltage provision

2: CCI analog provision. Can choose 0~10V voltage or 4~20mA current provision

3: Keypad analog potentiometer provision

F3.02	Feedback channel selection	Range: 0~6	0
-------	----------------------------	------------	---

0: VCI analog input voltage 0—10V

1: CCI analog input

2: VCI+CCI

3: VCI-CCI

4: Min {VCI, CCI}

5: Max {VCI, CCI}

When CCI analog input is selected to be current input, it will be converted to voltage value in the inverter.

6: Pulse feedback

F3.03	Specified value digital setting	Range: 0.00~9.999V	0.200V
	Target pressure value setting	Range:0.00~F3.21Mpa	0.200(Mpa)

When F3.00=1, figure given value F3.03 will be as specified value of closed-loop control system directly. At this time please setF3.21to 9.999(v);

When F3.00=2, Start PID control constant pressure water supply, At this point the water supply system F3.03 will become the target pressure value. Upper limit is F3.21Mpa.

F3.04	Min. specified value	Range: 0.0~max. specified value	0.0(%)
F3.05	Corresponding feedback value of min. specified value	Range: 0.0~100.0(%)	0.0(%)
F3.06	Max. specified value value	Range: Min. specified value ~100.0(%)	100.0(%)
F3.07	Corresponding feedback value of max. specified value	Range: 0.0%~100.0(%)	100.0(%)

F3.04~F3.07 define relation curve of analog closed-loop provision and expected feedback. Their set value is percentage of provision and feedback actual value relative to reference (10V or 20mA).

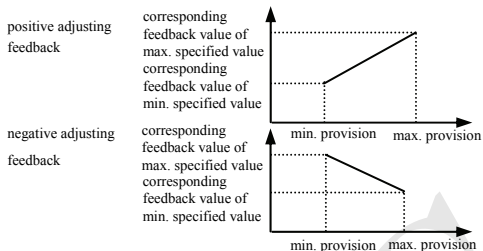

Fig.6-16 Provision, Feedback curve

F3.08	Proportion gain K_p	Range: 0.000~9.999	0.150
F3.09	Integral gain K_i	Range: 0.000~9.999	0.150
F3.10	Differential gain K_d	Range: 0.000~9.999	0.000
F3.11	Sampling cycle T	Range: 0.01~1.00S	0.10S

The more big K_p proportion gain is, the more quick the response is, but overbig is prone to bringing surge.

Only applying proportion gain K_p adjustment can't eliminate offset completely, can apply integral gain K_i and differential gain to make up of PID control in order to eliminate residual offset. The bigger K_i is, the more quickly the system responds to changing offset, but overbig is prone to bringing surge.

Sampling cycle T is sampling cycle for feedback value, during each sampling cycle PID adjustor calculate for one time, the longer the sampling cycle is, the slower the system responds.

F3.12	Offset limit	Range: 0.0~20.0(%)	2(%)
-------	--------------	--------------------	------

For Max. offset of closed-loop specified value, as shown in Fig.6-17, PID adjustor stops adjusting when feedback specified value is within this range. To utilize this function reasonably redound to harmonizing the conflict between system output precision and stabilization.

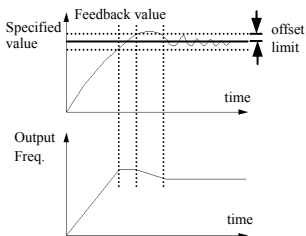

Fig.6-17 Offset limit

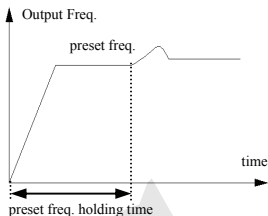

Fig.6-18 Closed-loop preset freq. run

F3.13	Integral separation PID adjusting threshold	Range: 0.0~100.0%	100.0%
-------	--	-------------------	--------

PID integral separation, integral don't react when specified value and feedback value are bigger than this limit, only when specified value and feedback value are smaller than or equal to this limit, integral react. Can adjust system response speed by adjusting this parameter.

F3.14	Closed-loop preset frequency	Range: 0~High limit freq.	0.00Hz
F3.15	Closed-loop preset frequency holding time	Range: 0.0~6000S	0.0S

This function can make closed-loop adjusting enter into stable phase quickly.

After closed-loop run starts, the inverter first accelerates to preset frequency F3.14 in terms of accelerating time, and after running at this frequency for a period of time F3.15, it runs according to closed-loop characteristic. As shown in Fig.6-18.



Set preset freq. and holding time to "0" if closed-loop preset freq. function is not needed.

F3.16	Revival frequency	Range: 0.00~400.00Hz	0.00Hz
F3.17	Sleep frequency	Range: 0.00~400.00Hz	0.00Hz

Revival frequency define frequency limit from sleep status to work status. If set frequency is bigger than this limit and the situation sustains for a revival delay time, the inverter will enter into work status from sleep status.

Sleep frequency define frequency limit from work status to sleep status. If set frequency is smaller than this limit and the situation sustains for a sleep delay time, the inverter will enter into sleep status from work status.

This function can realize sleep function and make energy save run possible, avoid the inverter staring at threshold frequency frequently.

F3.18	Sleep delay time	Range: 0.0~6000.0s	0.0s
--------------	-------------------------	---------------------------	-------------

This parameter is to set delay time when entering into sleep function. EDS800 will stop running if the output frequency is lower than sleep frequency and holding time longer than this sleep delay time.

F3.19	Revival delay time	Range: 0.0~6000.0s	0.0
--------------	---------------------------	---------------------------	------------

This parameter is to set delay time when entering into revival function.

F3.20	Reserved		
--------------	-----------------	--	--

F3.21	Long-distance manometer range	Range: 0.001~9.999Mpa	1.000
--------------	--------------------------------------	------------------------------	--------------

To set 10V or 20mA by this parameter.

F3.22 ~ F3.25	Reserved		
-----------------------------------	-----------------	--	--

F3.26	Water supply supervision Para. display	Range: 0, 1	0
--------------	---	--------------------	----------

0: C-11, C-12 display voltage value of VCI, CCI.

1: C-11, C-12 display PID specified pressure and feedback pressure.

F3.27	Closed-loop adjusting characteristic	Range: 0, 1	0
--------------	---	--------------------	----------

0: Forward function. motor speed increases as specified value increases.

1: Reverse function. motor speed decreases as specified value increases.

F3.28	LED initial supervision Para. selection	Range: 0~14	1
--------------	--	--------------------	----------

This parameter defines initial supervision parameter selection during running or stop. For example F3.28=3, LED displays output voltage initially, please press SHIFT key if you want to see about other supervision parameter.

0: Set frequency:It displays set-frequency when standby and displays output frequency when running.

1: Output frequency:It displays output frequency while running and standby.

2: Output current

3: Output voltage

4: DC bus bar voltage

5: Motor speed

6: Heat sink temperature

7: Run time

8: Accumulative run time

- 9: Input terminal status
- 10: Output terminal status
- 11: Analog input VCI/PID provision
- 12: Analog input CCI/PID feedback
- 13: Analog input YCI
- 14: Exterior pulse input

F3.28	LED initial supervision Para. selection	Range: 0~14	1
--------------	--	--------------------	----------

F3.29	YCI run-in delay time	Range: 0.0~9.999s	0.0s
--------------	------------------------------	--------------------------	-------------

YCI input delay time: the inverter first run at RS485 set frequency after start-up and change set frequency to RS485+YCI after delay time passed.

PID feedback signal loss detection: When F3.29=0.0, PID feedback signal loss detection protection function invalid, when F3.29≠0, feedback signal<12.5% given value and the constant time>F3.29, then you can judge the feedback signal loss, avoid damaging the equipment. Fault code is displayed as E017.

F3.30	Failure relay TA, TB, TC function selection	Range: 0~24	15
--------------	--	--------------------	-----------

Table 6-2 Failure relay TA, TB, TC function selection

Item	Corresponding function	Item	Corresponding function
0	Inverter running signal (RUN)	1	Frequency arriving signal (FAR)
2	Frequency level detecting signal (FDT1)	3	Reserved
4	Overload warning signal (OL)	5	Output Freq. reach high limit (FHL)
6	Output Freq. reach low limit (FLL)	7	Inverter stops for under voltage blockage (LU)
8	Stop for exterior failure (EXT)	9	Inverter zero speed running
10	In PLC run process	11	Simple PLC segment run finished
12	PLC finish one cycle run	13	Reserved
14	Inverter is ready for run (RDY)	15	Inverter failure
16	Traverse high&low limit restriction	17	Interior counter final value arrive
18	Interior counter specified value arrive	19	Set runtime arrive
20	Interior timer timing arrive	21	Reserved
22	FWD running	23	REV running
24	Reserved		

Now introduce function listed in Table 6-2 as follows:

0: Inverter during running (RUN). The inverter is in run status, output indicator signal.

1: Frequency arriving signal (FAR). Refer to function description of F5.14.

2: Frequency level detecting signal (FDT1). Refer to function description of

F5.15~F5.16.

3: Reserved

4: Overload warning signal (OL). Inverter output current exceed F9.05 overload detect level and time exceed F9.06 overload detect time, output indicator signal.

5: Output frequency reach high limit (FHL). When set frequency \geq high limit frequency and run frequency reach high limit frequency, output indicator signal.

6: Output frequency reach low limit (FLL). When set frequency \leq low limit frequency and run frequency reach low limit frequency, output indicator signal.

7: Inverter stops for under voltage blockage (LU). When the inverter is running, LED displays “P.OFF” and output indicator signal if DC bus-bar voltage is lower than limitative level.

8: Stop for exterior failure (EXT). When the inverter give the alarm (E014) and stops for exterior failure, output indicator signal.

9: Inverter zero speed running. When the inverter output zero frequency but in run status, output indicator signal.

10: In PLC run process

11: Simple PLC segment run finished. After simple PLC current segment run is finished, output indicator signal (Single pulse signal, width 500ms).

12: PLC finish one cycle run

13: Reserved

14: Inverter is ready for run (RDY). If this signal is effective, shows that bus-bar voltage is normal and run prohibition terminal is ineffective, the inverter can receive start-up command.

15: Inverter fault. If failure takes place when the inverter is running, the inverter output indicator signal.

16: Traverse high&low limit restriction. After choosing traverse function, if frequency fluctuant range based on center frequency of traverse is above high limit frequency F0.10 or under low limit frequency F0.11, the inverter will output indicator signal, as shown in Fig. 6-19.

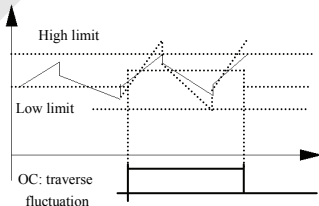

Fig.6-19 Traverse range restriction

17: Interior counter final value arrive

18: Interior counter specified value arrive

17~18 please refer to function description of F5.25~F5.26.

19: Set runtime arrive. When accumulative runtime of the inverter (F2.52) reach set runtime(F2.51), output indicator signal.

20: Interior timer timing arrive. Refer to function description for F5.27.

21: Reserved

22: FWD running

23: REV running

24: Reserved.

F3.31	Reserved		
-------	----------	--	--

6.5 Simple PLC run function parameter group: F4

The user can set by himself the output frequency direction and running time of the inverter during a running cycle by simple PLC function according to spot craft demand, as shown in Fig.6-21.

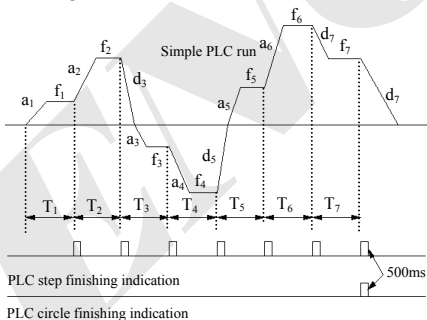

Fig.6-21 Simple PLC run

EDS800 serial inverter simple PLC run function provide 7 kinds of multi-step speed run mode, see below an example of 7 step speed. In Fig.6-22, a1~a5, d1~d5 is accelerating or decelerating time of relative step, set by accelerating decelerating time parameter F0.08, F0.09 and F2.18~F2.29 in total 7 kinds of parameter, f1~f7, T1~T7 indicating set frequency and run time set by function code F4.01~F4.14.

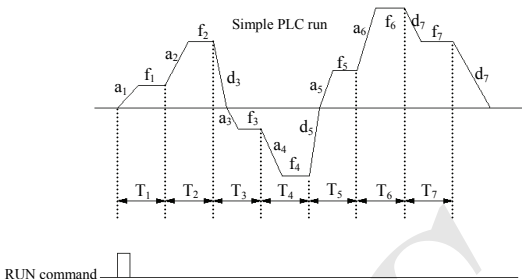

Fig.6-22 Stop after PLC single circle

PLC stop finishing and circle finishing indication can be realized by outputting 500mS pulse indicator signal through open circuit collector terminal OC, detailed function defined by F5.10.

F4.00	Simple PLC run setting	Range: LED Units digit: 0~3 LED Tens digit: 0~2 LED Hundreds digit: 0, 1 LED Thousands digit: 0, 1,2	0000
-------	------------------------	--	------

This function code make use of its 1st bit, 2nd bit, 3rd bit to set PLC run mode, PLC rerun mode after interruption, set run time unit, detail as follows:

LED Units digit:

0: No action. PLC run mode ineffective.

1: Stop after single circle. As shown in Fig.6-22, the inverter stops automatically after finishing a circle, can only start when another run command is available.

2: Keep final value after single circle. As shown in Fig.6-23, The inverter keep running according to frequency, direction of final step after finishing a circle, the inverter won't stop according to set decelerating time until the stop command is available.

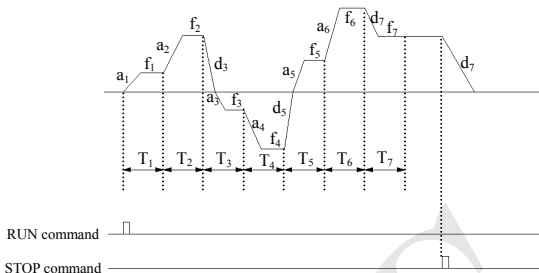

Fig.6-23 Holding mode after PLC single circle

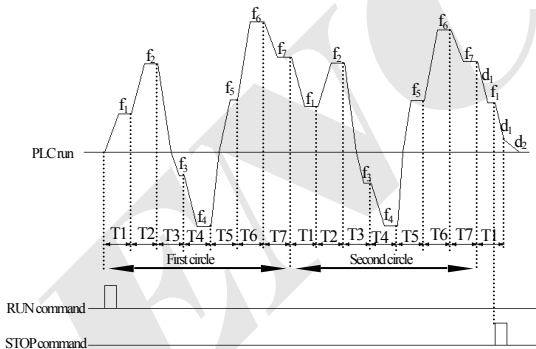

Fig.6-24 PLC consecutive circle mode

3: Consecutive circle. As shown in Fig.6-24, the inverter start next circle automatically after finishing a circle, until there is stop command.

LED Tens digit:

0: Start from first step. Stop during running caused by stop command, failure or power off, after restarting the inverter will run from first step.

1: Continue to run from step frequency of interruption moment. When stop during running caused by stop command or failure, the inverter will record current step used time automatically and enter into this step automatically after restarting, continue to run for residual time according to defined frequency of this step, as shown in Fig.6-25. The inverter will rerun from first step after restarting if power off.

2: Continue to run from the operation frequency of interruption moment.

When stop during running caused by stop command or failure, the inverter will record the current step used time and current operation frequency automatically. It will recover to the operation frequency of interruption moment and continue to run follow steps when restart as shown in Fig.6-26.

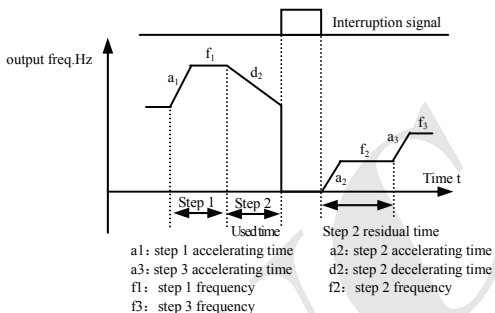

Fig.6-25 PLC starting mode 1

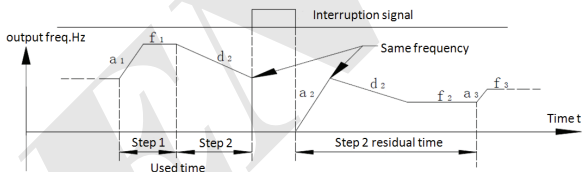

Fig.6-26 PLC starting mode 2

LED Hundreds digit : PLC run time unit

0: Second;

1: Minute

This unit is only effective to PLC run step time, for accelerating decelerating time of PLC run period, their unit selection is determined by F0.07.

LED Thousands digit:

0: Power off no memory

1: The inverter still in the memory running state when the power off, it needs renew run (Terminal control exceptional) when power on without automotive start. Make memory of the simple PLC running segments, speed and running time before power off. Automotive read the state of the power off when restart, but the inverter doesn't run directly, (Control commands except for the terminal mode), you need to run the command again.

2: The inverter will record running state when power off and automatically run after restarting. Make memory of the simple PLC running segments, speed and running time before power off, no need running command again directly run from the state of power off after restart.



- (1) If run time of PLC segment is set to 0, This segment is ineffective.
 (2) Can make PLC process a pause, ineffective, work etc. through terminal, for detail please refer to terminal correlative function parameter group F5.

F4.01	Step 1 setting	Range: 000~621	000
F4.02	Step 1 runtime	Range: 0~6000.0	10.0
F4.03	Step 2 setting	Range: 000~621	000
F4.04	Step 2 runtime	Range: 0~6000.0	10.0
F4.05	Step 3 setting	Range: 000~621	000
F4.06	Step 3 runtime	Range: 0~6000.0	10.0
F4.07	Step 4 setting	Range: 000~621	000
F4.08	Step 4 runtime	Range: 0~6000.0	10.0
F4.09	Step 5 setting	Range: 000~621	000
F4.10	Step 5 runtime	Range: 0~6000.0	10.0
F4.11	Step 6 setting	Range: 000~621	000
F4.12	Step 6 runtime	Range: 0~6000.0	10.0
F4.13	Step 7 setting	Range: 000~621	000
F4.14	Step 7 runtime	Range: 0~6000.0	10.0

F4.01~F4.14 utilize LED 1st bit, 2nd bit, 3rd bit to separately define frequency setting, direction and accelerating decelerating time of PLC Run, see following for detail:

LED Units digit: frequency setting

0: Multi-step frequency $i = 1 \sim 7$ is defined by F2.30~F2.44.

1: Frequency is determined by function code F0.00

LED Tens digit: run direction selection

0: Forward run

1: Reverse run

2: Determined by run command (FWD,REV)

LED Hundreds digit: accelerating decelerating time selection

0: Accelerating decelerating time 1

1: Accelerating decelerating time 2

2: Accelerating decelerating time 3

3: Accelerating decelerating time 4

4: Accelerating decelerating time 5

5: Accelerating decelerating time 6

6: Accelerating decelerating time 7

6.6 Terminal correlative function parameter group: F5

F5.00	Input terminal X1 function selection	Range: 0~42	0
F5.01	Input terminal X2 function selection	Range: 0~42	0
F5.02	Input terminal X3 function selection	Range: 0~42	0
F5.03	Input terminal X4 function selection	Range: 0~42	0
F5.04	Input terminal X5 function selection	Range: 0~42	0
F5.05	Reserved		
F5.06	Reserved		
F5.07	Reserved		

Multi-function input terminal X1~X5 provides 43 kinds of selection mode for the user, can choose based on spot requirement. For parameter function table please see Table 6-3.

Table 6-3 Multifunction input function selection table

Item	Corresponding function	Item	Corresponding function
0	Leave control terminal unused	1	Multi-step speed control terminal 1
2	Multi-step speed control terminal 2	3	Multi-step speed control terminal 3
4	Multi-step speed control terminal 4	5	External forward run jog control
6	External reverse run jog control	7	Accel/Decel time selecting terminal 1
8	Accel/Decel time selecting terminal 2	9	Accel/Decel time selecting terminal 3
10	External device failure input	11	External restoration input
12	Free stop input	13	External stop command
14	stop DC braking input command DB	15	Inverter run prohibition
16	Frequency increasing command (UP)	17	Frequency descending
18	Accel/Decel prohibited command	19	Three-wire run control
20	Closed-loop ineffective	21	PLC ineffective
22	Simple PLC pause command	23	PLC stop status restoration (Reset variable of PLC interruption moment, make it restart from first segment)
24	Frequency provision channel selection 1	25	Frequency provision channel selection 2
26	Frequency provision channel selection 3	27	Frequency switched to CCI
28	Command switched to terminal	29	Run command channel selection 1
30	Run command channel selection 2	31	Run command channel selection 3
32	Traverse runin	33	External interruption input

34	Interior counter clearing end	35	Interior counter triggering end
36	Interior timer clearing end	37	Interior timer triggering end
38	Pulse frequency input (only effective for X5)	39	Pulse width frequency input (Only for X5)
40	Reserved	41	Reserved
42	Reserved		

Now explain listed function in Table 6-3 as follows:

1~4: Multi-step speed control terminal. Can set 15 step speed run frequency by choosing ON/OFF combination of these function terminal.

Table 6-4 Multi-step speed run selection table

K ₄	K ₃	K ₂	K ₁	Frequency setting
OFF	OFF	OFF	OFF	Common run frequency
OFF	OFF	OFF	ON	Multi-step frequency 1
OFF	OFF	ON	OFF	Multi-step frequency 2
OFF	OFF	ON	ON	Multi-step frequency 3
OFF	ON	OFF	OFF	Multi-step frequency 4
OFF	ON	OFF	ON	Multi-step frequency 5
OFF	ON	ON	OFF	Multi-step frequency 6
OFF	ON	ON	ON	Multi-step frequency 7
ON	OFF	OFF	OFF	Multi-step frequency 8
ON	OFF	OFF	ON	Multi-step frequency 9
ON	OFF	ON	OFF	Multi-step frequency 10
ON	OFF	ON	ON	Multi-step frequency 11
ON	ON	OFF	OFF	Multi-step frequency 12
ON	ON	OFF	ON	Multi-step frequency 13
ON	ON	ON	OFF	Multi-step frequency 14
ON	ON	ON	ON	Multi-step frequency 15

Above multi-step frequency can be used in multi-step speed run and simple PLC run, please see below an example of multi-step speed run:

We now define control terminal X1, X2, X3, X4 separately as follows:

After set F5.00=1, F5.01=2, F5.02=3, F5.03=4, X1, X2, X3, X4 are used for realizing multi-step run, as shown in Fig.6-27.

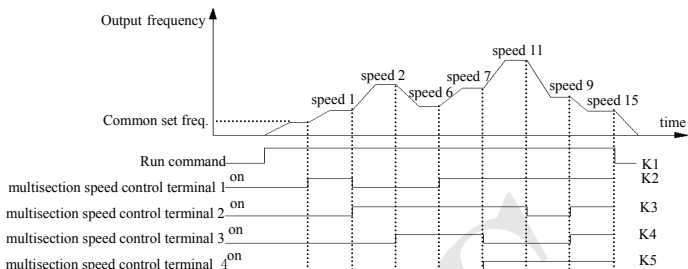

Fig.6-27 Multi-step speed run

In Fig.6-28 see an example of terminal run command channel, can make forward, reverse run control by K5, K6. In Fig.6-27, by different logic combination of K1, K2, K3, K4, the inverter can run according to common set frequency or multi-step frequency based on above table.

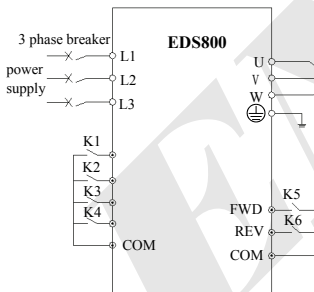

Fig.6-28 Multi-step speed run

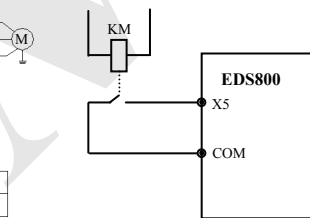

Fig.6-29 Exterior device failure always-open input

5-6: external jog run control input JOGF/JOGR. When run command channel is set to terminal run command channel F0.02=1, JOGF is jog forward run, JOGR is jog reverse run, jog operation frequency, jog accelerating decelerating time is defined in F2.06~F2.08 (Remark: Jog run command channel is determined by F0.02)

7-9: Accel&Decel time terminal selection

Table 6-5 Accel&Decel time terminal selection logic mode

Terminal 2	Terminal 2	Terminal 1	Accel/Decel time selection
OFF	OFF	OFF	Accel time 1/ Decel time 1
OFF	OFF	ON	Accel time 2/ Decel time 2

OFF	ON	OFF	Accel time 3/ Decel time 3
OFF	ON	ON	Accel time 4/ Decel time 4
ON	OFF	OFF	Accel time 5/ Decel time 5
ON	OFF	ON	Accel time 6/ Decel time 6
ON	ON	OFF	Accel time 7/ Decel time 7

Can realize selection for Accel&Decel time1~7 by ON/OFF combination of Accel&Decel time terminal.

10: External equipment fault input. Can input fault signal of external equipment by this terminal to be convenient for the inverter to monitor fault of external equipment. The inverter displays “E0.14”, namely external equipment fault alarm after receiving the external equipment fault signal.

11: Exterior restoration input. After the fault alarm takes place in the inverter, can restore the inverter through this terminal. Its function is same as function of **RESET** key on the operation panel.

12: Free stop input. This function is same as free stop during running defined in F1.05, but it's realized by control terminal to be convenient for long-distance control.

13: Exterior stop command. This command is effective to all run command channel, when this function is effective the inverter stops running in mode set by F1.05.

14: DC injection braking input command DB during stop. Implement DC injection braking to the motor during stop by control terminal, in order to realize urgent parking and accurate orientation of the motor. Braking initial frequency, braking time are defined in F1.06, F1.07.

15: Inverter run forbiddance. The inverter during running stops freely when this terminal is effective and forbidden to start in waiting status. Mainly applied to occasion needing safe linkage.

16~17: Frequency increasing command UP/descending command DOWN. Realize frequency increasing or descending by control terminal, which substitute for keypad to realize long-distance control. Effective during common run if F0.00=2. Increasing descending speed is set by F5.09.

18: Accel&Decel speed forbidden command. Let the motor not effected by any foreign signal(except stop command), keep running at current frequency.



Note

Ineffective during normal decelerating stop.

19: Three-wire run control. Please refer to function description of F5.08 run mode (Three-wire run mode).

20: Closed-loop ineffective. Realize flexible switch to lower level run mode under closed-loop run status.



- (1) Can switch between closed-loop and lower level run mode only during closed-loop run (F3.00=1).
- (2) Start stop control, direction and Accel&Decel time are subject to setting of corresponding run mode when it's switched to lower level run mode.

21: PLC ineffective. Realize flexible switch to lower level run mode under PLC run status.



- (1) Can switch between PLC and lower level run mode only during PLC run(F4.00≠0).
- (2) Start stop control, direction and Accel&Decel time are subject to setting of corresponding run mode when it's switched to lower level run mode.

22: Simple PLC pause command. Implement pause control to PLC process during running, run at zero frequency when this terminal is effective, not time for PLC run .after ineffective implement automatic speed tracking start and continue PLC run. For application method please refer to function description of F4.00~F4.14.

23: PLC stop status restoration. Under stop status of PLC run mode, will clear PLC run step, runtime, run frequency etc. recorded when PLC run stops if this terminal is effective, please see F4 group function description.

24~26: Terminal frequency provision channel selection. Through ON/OFF combination of frequency provision channel selection terminal 24, 25, 26, can realize frequency provision channel switch shown in Table 6-6. For relation of terminal switch and function code F0.00 setting, that is, latter effective.

Table 6-6 Terminal frequency provision channel selection logic mode

Frequency provision channel selection end 3	Frequency provision channel selection end 2	Frequency provision channel selection end 1	Frequency provision channel selection
OFF	OFF	OFF	Hold freq. setting
OFF	OFF	ON	Potentiometer provision
OFF	ON	OFF	Keypad number provision
OFF	ON	ON	Terminal UP/DOWN adjusting provision
ON	OFF	OFF	Serial port provision
ON	OFF	ON	VCI
ON	ON	OFF	CCI
ON	ON	ON	End PULSE provision

27: Switch frequency to CCI. Frequency provision channel is switched to CCI provision compulsorily when this function terminal is effective, frequency provision channel come back to previous status when this function terminal is ineffective.

28: Command switched to terminal. Run command channel is switched to terminal run command channel compulsorily when this function terminal is

effective.

29~31: Terminal select run command channel

Table 6-7 Run command channel logic mode

Run command channel selection terminal 3	Run command channel selection terminal 2	Run command channel selection terminal 1	Run command channel
OFF	OFF	OFF	Hold run command channel
OFF	OFF	ON	Keypad run command channel
OFF	ON	OFF	End run command channel (Keypad STOP command ineffective)
OFF	ON	ON	End run command channel (Keypad STOP command effective)
ON	OFF	OFF	Serial port run command channel (Keypad STOP command ineffective)
ON	OFF	ON	Serial port run command channel (Keypad STOP command effective)

Can realize control command selection shown in Table 6-7 by ON/OFF combination of run command channel selection terminal, For relation of terminal switch and function code F0.00 setting, that is, latter effective.

32: Traverse jump-in. When traverse start mode is manual jump-in, traverse function effective if this terminal effective, see F6 function parameter description.

33: Exterior interruption input. The inverter close off output and run at zero frequency during running upon receiving exterior interruption signal. The inverter implement automatic speed tracking start-up to resume running once external interruption signal is relieved.

34: Interior counter clearing end. To clear built-in counter in the inverter with cooperation of counter triggering signal.

35: Interior counter triggering end. Counting pulse input port of built-in counter, pulse max. frequency: 200Hz, see function code F5.24, F5.25.

36: Interior timer clearing end. To clear built-in timer in the inverter with cooperation of timer triggering signal.

37: Interior timer triggering end. Please see function description for parameter F5.27.

38: Pulse frequency input (only effective to X5). Only effective for multifunction input terminal X5, this function terminal receive pulse signal as frequency provision, for relation between inputted signal pulse frequency and set frequency in detail, please refer to F7 group parameter.

39: Reserved**40: Reserved****41: Reserved****42: Reserved**

F5.08	FWD/REV run mode selection	Range: 0~3	0
--------------	-----------------------------------	-------------------	----------

This parameter defines 4 kinds of exterior terminal control mode for inverter running.

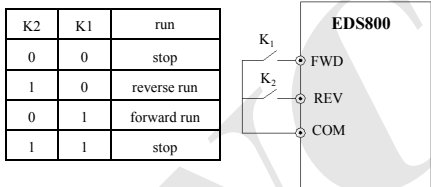
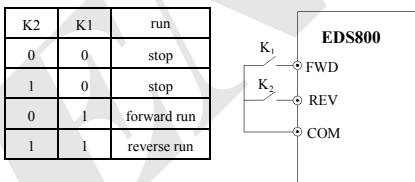
0: 2-wire control mode 1**Fig.6-30 2-wire run mode 1****0: 2-wire control mode 2****Fig.6-31 2-wire run mode 2****2: 3-wire control mode 1**

There into:

SB1: stop button

SB2: forward run button

SB3: reverse run button

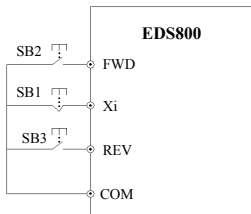
**Fig.6-32 3-wire run mode 1**

Xi is multifunction input terminal of X1~X5, here should define its corresponding terminal function as No. 19 “3-wire run control” function.

3: 3-wire control mode 2

SB1: stop button

SB2: run button

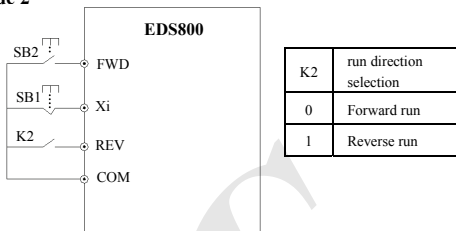

Fig.6-33 3-wire run mode 2

Xi is multifunction input terminal X1~X5, here should define its corresponding terminal function as No. 19 “3-wire run control” function.

The inverter restores after failure and start at once if run command channel selecting terminal and terminal FWD/REV is effective during warning alarm stop.

F5.09	UP/DOWN speed	Range: 0.01~99.99Hz/s	1.00Hz/s
-------	---------------	-----------------------	----------

This function code defines varying rate of the set frequency when it's modified by UP/DOWN terminal.

F5.10	Open collector output terminal OC output setting	Range: 0~24	0
F5.11	Reserved		
F5.12	Reserved		
F5.13	Reserved		

OC open collector output terminal, Table 6-8 shows option of above 4 function parameter, choosing same output terminal function repeatedly is allowed.

Table 6-8 Output terminal function selection table

Item	Corresponding function	Item	Corresponding function
0	Inverter running signal (RUN)	1	Frequency arriving signal (FAR)
2	Frequency level detectingsignal (FDT1)	3	Reserved
4	Overload warning signal(OL)	5	Output Freq. reach high limit(FHL)
6	Output Freq. reach low limit(FLL)	7	Inverter stops for under voltage blockage (LU)
8	Stop for exterior failure(EXT)	9	Inverter zero speed running
10	In PLC run process	11	Simple PLC segment run finished
12	PLC finish one cycle run	13	Reserved

14	Inverter is ready for run (RDY)	15	Inverter failure
16	Traverse high&low limit restriction	17	Interior counter final value arrive
18	Interior counter specified value arrive	19	Set runtime arrive
20	Interior timer timing arrive	21	Reserved
22	FWD running	23	REV running
24	Reserved		

Now introduce function listed in Table 6-8 as follows:

0: Inverter during running (RUN). The inverter is in run status, output indicator signal.

1: Frequency arriving signal (FAR). Refer to function description of F5.14.

2: Frequency level detecting signal (FDT1). Refer to function description of F5.15~F5.16.

3: Reserved

4: Overload warning signal (OL). Inverter output current exceed F9.05 overload detect level and time exceed F9.06 overload detect time, output indicator signal.

5: Output frequency reach high limit (FHL). When set frequency \geq high limit frequency and run frequency reach high limit frequency, output indicator signal.

6: Output frequency reach low limit (FLL). When set frequency \leq low limit frequency and run frequency reach low limit frequency, output indicator signal.

7: Inverter stops for under voltage blockage (LU). When the inverter is running, LED displays“P.OFF” and output indicator signal if DC bus-bar voltage is lower than limitative level.

8: Stop for exterior failure (EXT). When the inverter give the alarm (E014) and stops for exterior failure, output indicator signal.

9: Inverter zero speed running. When the inverter output zero frequency but in run status, output indicator signal.

10: In PLC run process

11: Simple PLC segment run finished. After simple PLC current segment run is finished, output indicator signal (Single pulse signal, width 500ms).

12: PLC finish one cycle run

13: Reserved

14: Inverter is ready for run (RDY). If this signal is effective, shows that bus-bar voltage is normal and run prohibition terminal is ineffective, the inverter can receive start-up command.

15: Inverter fault. If failure takes place when the inverter is running, the inverter output indicator signal.

16: Traverse high&low limit restriction. After choosing traverse function, if frequency fluctuant range based on center frequency of traverse is above high limit frequency F0.10 or under low limit frequency F0.11, the inverter will output indicator signal, as shown in Fig. 6-34.

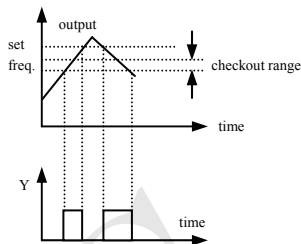
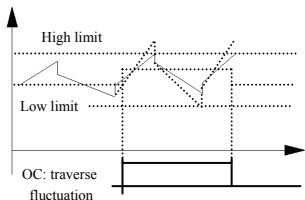

Fig.6-34 Traverse range restriction

Fig.6-35 Freq. arriving signal output

17: Interior counter final value arrive

18: Interior counter specified value arrive

17~18 please refer to function description of F5.25~F5.26.

19: Set runtime arrive. When accumulative runtime of the inverter (F2.52) reach set runtime (F2.51), output indicator signal.

20: Interior timer timing arrive. Refer to function description for F5.27.

21: Reserved

22: FWD running

23: REV running

24: Reserved

F5.14	Freq. arriving(FAR)detect range	Range: 0.00~50.00Hz	5.00Hz
-------	---------------------------------	---------------------	--------

This parameter is supplementary definition to No. 1 function in Table 6-8. As shown in Fig.6-35, when output frequency of the inverter is within high&low detect range of set frequency, output pulse signal.

F5.15	FDT1 (freq. level) electric level	Range: 0.00~high limit frequency	10.00Hz
F5.16	FDT1 lag	Range: 0.00~50.00Hz	1.00Hz

F5.15~F5.16 is supplementary definition to No.2 function in Table 6-8, introduce as follows: When output frequency exceed the set frequency (FDT1 electric level), output indicator signal, till output frequency descend to be some frequency (FDT1 electric level-FDT1 lag) lower than FDT1 electric level, as shown in Fig.6-36.

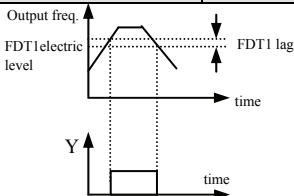

Fig.6-36 freq. level detecting

F5.17	Analog output (AO) selection	Range: 0~9	0
-------	------------------------------	------------	---

0: Output frequency (0-High limit frequency)

1: Set frequency (0-High limit frequency)

2: Output current (0-2×rated current)

3: Output voltage (0-1.2×load motor rated voltage)

4: Bus-bar voltage (0-800V)

5: PID provision (0.00-10.00V)

6: PID feedback (0.00-10.00V)

F5.18	Analog output (AO) gain	Range: 0.00~2.00	1.00
F5.19	Analog output (AO) offset	Range: 0.00~10.00V	0.00

For AO analog output, the user can modify display measuring range or emend meter head error by adjusting output gain if necessary.

F5.20	Reserved		
F5.21	Reserved		
F5.22	Reserved		

F5.23	DO terminal output function selection	Range: 0~9	0
-------	---------------------------------------	------------	---

Same as F5.17 function parameter description.

F5.24	DO max. pulse output freq.	Range: 0.1~20.0 (max. 20KHz)	10.0
-------	----------------------------	------------------------------	------

DO port max. output pulse frequency corresponds to maximum value optioned by F5.23, for example 0: output frequency, then max. Output pulse frequency corresponds to high limit frequency.

F5.25	Set interior count number arriving provision	Range: 0~9999	0
F5.26	Specified interior count number arriving provision	Range: 0~9999	0

F5.25, F5.26 is supplementary definition to No. 17, 18 function in Table 6-8.

Set count number provision, shows that when some number of pulse are inputted to Xi (count triggering signal input function terminal), OC (open collector Output terminal) output a indicator signal.

As shown in Fig.6-37, OC output an indicator signal when the 8th pulse is inputted to Xi. Here F5.25=8.

Specified count number provision, shows that when some number of pulse are inputted to Xi, Yi output a indicator signal, till set count number is reached.

As shown in Fig.6-37, TA, TB, TC start to output an indicator signal when the 5th pulse is inputted to Xi. Until set count number 8 is reached. Here F5.26=5. Specified count number is ineffective when it is bigger than set count number.

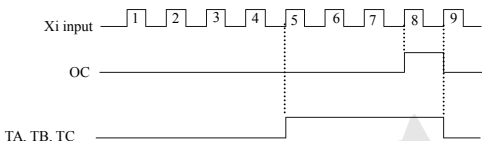

Fig.6-37 set count number and specified count number provision

F5.27	Interior timer timing setting	Range: 0.1~6000.0s	60.0
-------	-------------------------------	--------------------	------

This parameter is used to set timing time of interior timer of the inverter. The timer is activated by exterior triggering end (triggering end selected by F5.00~F5.07), the timer begins timing upon receiving exterior triggering signal, after it's up to timing time one effective pulse signal of 0.5s will be outputted from relative OC end

6.7 Traverse special function parameter group: F6

F6.00	Traverse function selection	Range: 0, 1	0
-------	-----------------------------	-------------	---

0: Traverse function ineffective

1: Traverse function effective

F6.01	Traverse run mode	Range: Units digit: 0, 1 Tens digit: 0, 1 Hundreds digit: 0, 1 Thousands digit: 0, 1	0000
-------	-------------------	---	------

0: Automatic jump-in mode. After start-up run at traverse preset frequency for a period of time, then enter into traverse operation automatically.

1: terminal manual run mode. When set the multifunction terminal Xi (Xi=X1~X5) to function 32 and it's effective, enter into traverse state; quit traverse state if ineffective and run frequency is at traverse preset frequency.

LED Tens digit:

0: Changing amplitude. Amplitude AW varies with center frequency, for its changing rate please see F6.02 definition.

1: Fixed amplitude. Amplitude AW is determined by high limit frequency and F6.02.

LED Hundreds digit: Traverse halt start mode selection:

0: Restart

1: Restart according to halt record

LED Thousands digit: Traverse status save selection:

0: No save**1: Save**

Traverse center frequency input setting channel is set by F0.00 function.

F6.02	Traverse amplitude	Range: 0.0~50.0(%)	0.0(%)
--------------	---------------------------	---------------------------	---------------

Changing amplitude: $AW = \text{center frequency} \times F6.02$ Fixed amplitude: $AW = \text{high limit frequency} \times F6.02$ **Note**

Traverse run frequency is restricted by high limit, low limit frequency; if set improperly, abnormal traverse operation arise.

F6.03	Sudden jumping freq.	Range: 0.0~50.0 (%)	0.0(%)
--------------	-----------------------------	----------------------------	---------------

As shown in Fig.6-37.If this parameter is set to 0, no jumping frequency.

F6.04	Traverse cycle	Range: 0.1~999.9S	10.0S
--------------	-----------------------	--------------------------	--------------

Whole time for a cycle including traverse rising, descending process.

F6.05	Triangle wave rising time	Range: 0.0~98.0(%) (Traverse cycle)	50.0(%)
--------------	----------------------------------	--	----------------

Define runtime of traverse rising segment = $F6.04 \times F6.05$ (s), runtime of descending segment = $F6.04 \times (1 - F6.05)$ (s). Please refer to description in Fig.6-38.

F6.06	Traverse preset frequency	Range: 0.00~400.00Hz	0.00Hz
--------------	----------------------------------	-----------------------------	---------------

F6.07	Traverse preset frequency latency time	Range: 0.0~6000S	0.0S
--------------	---	-------------------------	-------------

F6.06 is used for defining inverter run frequency before entering into traverse operation.

When automatic start-up mode is optioned, F6.07 is used for setting holding time running at traverse preset frequency before enter into traverse operation; When manual start-up mode is optioned, F6.07 setting is ineffective. Please see description in Fig.6-38.

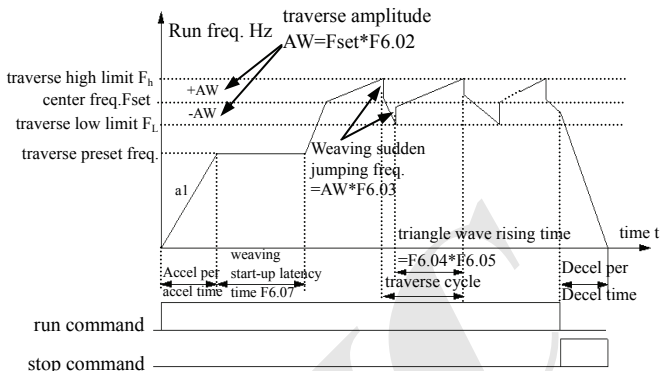

Fig. 6-38 Traverse

6.8 Frequency provision function parameter group: F7

F7.00	VCI minimum provision	Range: 0.00~F7.02	0.0V
F7.01	Corresponding freq. to VCI minimum provision	Range: 0.00~High limit frequency	0.00Hz
F7.02	VCI max. provision	Range: 0.00~10.00V	10.0V
F7.03	Corresponding freq. to VCI maximum provision	Range: 0.00~high limit frequency	50.00Hz
F7.04	CCI minimum provision	Range: 0.00~F7.06	0.00V
F7.05	Corresponding freq. to CCI minimum provision	Range: 0.00~High limit frequency	0.00Hz
F7.06	CCI max. provision	Range: 0.00~10.00V	10.00V
F7.07	Corresponding freq. to CCI max. provision	Range: 0.00~High limit frequency	50.00Hz
F7.08	Max. Input pulse width	Range:0.1-999.9ms (whenF0.00=11)	100.0ms
F7.09	Min. Input pulse width	Range:0.0~F7.11(Max.provision pulse)(whenF0.00=11)	0.0ms
F7.10	min. provision corresponding freq.	0.00~high limit frequency	0.00Hz
F7.11	Max. provision pulse width	Rang:F7.09 (Min.provision pulse) ~F7.08 (Max.provision pulse)	100.0ms
F7.12	max. provision corresponding freq.	Range: 0.00~high limit frequency	50.00Hz

When choose F0.00=11(terminal pulse setting freq.).the function of above parameter effective.

Pulse width in milliseconds, The freq. of input pulse width can effect the precision of output freq., to assure the precision of output freq.,customer advised use the freq. of pulse width between 1Hz to 100Hz.

Please don't use these function for the application where there use close freq control.

F7.13	PULSE max. pulse input	Range: 0.1~20.0K	10.0K
F7.14	PULSE minimum provision	Range: 0.0~F7.16	0.0K
F7.15	Corresponding freq. to PULSE min. provision	Range: 0.00~High limit frequency	0.00Hz
F7.16	PULSE max. provision	Range: F7.14 (PULSE min. provision)~F7.13 (Max. input pulse)	10.0K
F7.17	Corresponding freq. to PULSE max. provision	Range: 0.00~High limit frequency	50.00Hz

F2.00 sets the analog channel filtering time constant, to filter input signal, the more long filtering time is, the more great anti-jamming ability is, but response speed descend; The more short filtering time is, the more fast the inverter respond, but anti-jamming ability is weakened.

See below relation curve of VCI and set frequency:

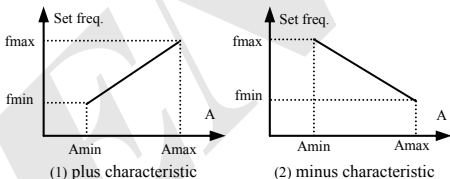

A:VCI provision

Amin:min. provision

Amax:max. provision

fmin:corresponding freq. of min. provision

fmax:corresponding freq. of max. provision

See below relation curve of CCI and set frequency:

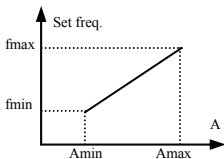

(1) plus characteristic

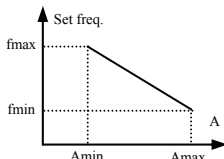

(2) minus characteristic

A: CCI provision

Amin:min. provision

Amax:max. provision

fmin:corresponding freq. of min. provision

fmax:corresponding freq. of max. provision

See below relation curve of PULSE and set frequency:

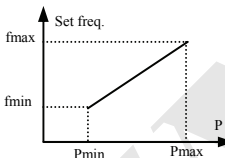

(1) plus characteristic

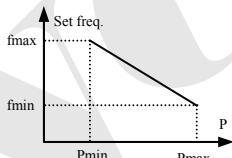

(2) minus characteristic

P: PULSE provision

Pmin: min. provision

Pmax: max. provision

fmin: corresponding freq. to min. provision

fmax: corresponding freq. to max. provision

6.9 Motor and vector control function parameter group: F8

F8.00	Reserved		
F8.01	Motor rated voltage	Range: 1~999V	Depend on device type
F8.02	Motor rated current	Range: 0.1~999.9A	Depend on device type
F8.03	Motor rated frequency	Range: 1.00~400.00Hz	Depend on device type
F8.04	Motor rated speed	Range: 1~9999r/min	Depend on device type
F8.05	Motor pole	Range: 2~14	Depend on device type
F8.06	Motor rated power	Range: 0.1~999.9KW	Depend on device type
F8.07 ~ F8.17	Reserved		

Please set F8.01~F8.06 according to rated data of driven motor for safety.

6.10 Protection function parameter: F9

F9.00	Reserved		
-------	----------	--	--

F9.01	Failure self-restoration times	Range: 0~10	0
F9.02	Failure self-restoration interval	Range: 0.5~20.0S	5.0S

During run process, failure will take place accidentally due to load fluctuation and the inverter will cut off output, here failure self-restoration function can be applied in order to let the device continue to run. During self-restoration, the inverter will try to resume running in speed checking restart mode but stop outputting and failure protected if the inverter can't resume running successfully within set times. Self-restoration function will be shut down if failure self-restoration times is set to 0.



- (1) To use failure self-restoration function must take device allowance and no essential failure in the inverter as preconditions.
- (2) Self-restoration function is ineffective to failure protection caused by overload and over heat.

F9.03	Motor overload protection mode selection	Range: 0, 1	1
-------	--	-------------	---

This parameter defines protecting action mode when overload, overheat take place in the inverter.

0: No action. No motor overload protection characteristic(apply with caution), here the inverter have no overload protection for load motor;

1: Inverter cut off output at once. The inverter cut off output and motor stopfreely when overload, overheat take place.

F9.04	motor overload protection coefficient	Range: 20.0~120.0(%)	100.0(%)
-------	---------------------------------------	----------------------	----------

This parameter sets sensibility of the inverter implementing thermal relay protection to load motor, can implement correct heat protection to the motor by setting this value when output current value of load motor don't match rated current of the inverter, as shown in Fig.6-39.

Value of this parameter can be determined by following formula:

$$F9.04 = \frac{\text{Motor rated current}}{\text{Inverter rated output current}} \times 100$$



Note

The inverter will lose thermal relay protection function when a piece of inverter drive multiple motors in parallel. Please assemble heat protection relay at input side of each motor to protect them effectively.

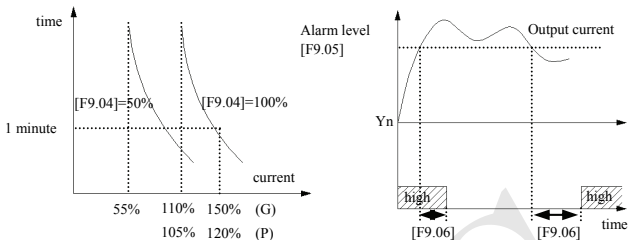

Fig.6-39 Electronic thermal relay protection **Fig.6-40 Overload alarm**

F9.05	Overload alarm checkout level	Range: 20~200(%)	130(%)
F9.06	Overload alarm delay time	Range: 0.0~20.0S	5.0S

If output current exceeds electric level set by parameter F9.05 continuously, open collector outputs effective signal(refer to Fig.6-40 and interrelated description of parameter F5.10) after delay time set by F9.06 passed.

F9.07	Overvoltage stall selection	Range: 0, 1	1
F9.08	Stall overvoltage point	Range: 120~150(%)	140(%)

0: Banned

1: Allowed

Actual descending rate of motor speed may be lower than that of output frequency due to effect from load inertia when the inverter is in decelerating run process, here the motor will feed electric energy back to inverter which will make DC bus-bar voltage of the inverter increase, overvoltage protection will takes place if not take steps. Overvoltage stall protection function, indicates that output frequency of the inverter stops descending if bus-bar voltage detected during run process exceed stall voltage point defined by F9.08 (relative to standard bus-bar voltage) and the inverter continue to implement decelerating run when bus-bar voltage detected again is lower than stall overvoltage point. As shown in Fig. 6-41.

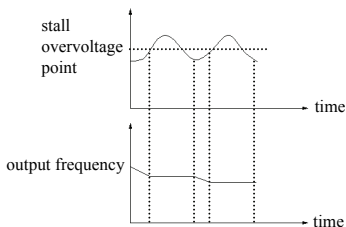

Fig.6-41 Over voltage stall function

F9.09	Automatic current limiting level	Range: 110~200(%)	150(%)
F9.10	Frequency descending rate during current limiting	Range: 0.00~99.99Hz/S	10.00Hz/S
F9.11	Automatic current limiting action selection	Range: Units digit: 0, 1 Tens digit: 0, 1	00

By automatic current limiting function the inverter can limit load current not to exceed automatic current limiting level set by F9.09 to avoid tripping out for failure caused by rushing current. This function is especially suitable for some biggish inertia or acutely changing load occasion.

Automatic current limiting (F9.09) defines current threshold value of automatic current limiting action, its value is the percentage relative to inverter rated current.

Frequency descending rate during current limiting (F9.10) defines adjusting rate to output frequency during automatic current limiting action.

If frequency descending rate during automatic current limiting F9.10 is too small, inverter isn't easy to get rid of automatic current limiting state which may cause overload failure finally; If descending rate F9.10 is too big, the inverter may be in generating state for long time which will cause overvoltage protection.

Automatic current limiting function is effective in accelerating decelerating state and whether it's effective in constant speed run state is determined by automatic current limiting action selection (F9.11).

F9.11=0 indicates that automatic current limiting is ineffective during constant speed running;

F9.11=1 indicates that automatic current limiting is effective during constant speed running;

Output frequency may varies during automatic current limiting action, so automatic current limiting function is not suitable for occasion demanding stable output frequency during constant speed run.

Tens digit: Input loss phase detection

0: Invalid

1: Valid

6.11 Failure record function parameter: Fd

Fd.00	Previous one failure record	Range: 0~23	0
Fd.01	Previous two failure record	Range: 0~23	0
Fd.02	Previous three failure record	Range: 0~23	0
Fd.03	Previous four failure record	Range: 0~23	0
Fd.04	Previous five failure record	Range: 0~23	0
Fd.05	Previous six failure record	Range: 0~23	0

0: No failure

1~23: Failure E0.01~E0.23, please see chapter 7 for specified failure type.

Fd.06	Set freq. at previous failure	Range: 0~High limit	0
Fd.07	Output freq. at previous failure	Range: 0~high limit	0
Fd.08	output current at previous failure	Range: 0~999.9A	0
Fd.09	output volt. at previous failure	Range: 0~999V	0
Fd.10	DC bus-bar vlot. at previous failure	Range: 0~800V	0
Fd.11	Load motor speed at previous failure	Range: 0~9999	0
Fd.12	Module temp. at previous failure	Range: 0~100	0
Fd.13	Input end state at previous failure		0
Fd.14	Accu. runtime at previous failure	Range: 0~65535h	0

6.12 Code and manufacturer function parameter: FF



FF.00	User password	Range: 0000—9999	0000
-------	---------------	------------------	------

User password setting function is used for prohibiting unauthorized personnel from consulting and modifying function parameter.

Set this function code to 0000 when user password function isn't wanted.

First input 4 bits number as user password and press  key to confirm, then the password will come into effect at once.

Password modification:

Enter into password verification state by pressing  key, after inputting primary 4 bits password parameter editing state is available, choose FF.00(here FF.00=0000), input new password and press  key to confirm, then the password come into effect at once.



Note

Please keep the password you set without fail, in case the password is missing please consult the manufacturer.

FF.01	Manufacturer password	Range: 0000~9999	0000
-------	-----------------------	------------------	------

Setting function for the manufacturer, user need not modify it.

7 Troubleshooting



7.1 Failure and countermeasure



Possible failure types in EDS800 are shown in Table 7-1 and failure code is from E001 to E023. Some failure code is reserved for intelligent automatic diagnosis function which will be executed continuously in future. When failure takes place in the inverter, the user should check according to note of this table first and record failure phenomena detailedly. Please contact our after-sale service and technical support Department or agent in your local place when technical service is needed.

Table 7-1 Failure type and the countermeasure

Failure code	Failure type	Possible reason	Countermeasure
E001	Overcurrent during accelerating process	Accelerating time is too short	Prolong accelerating time
		Improper V/F curve	Adjust V/F curve setting, adjust manual torque boost or change to automatic torque boost
		Restart rotating motor	Set speed checking restart function
		Low power source voltage	Check input power supply
		Too small power of the inverter	Choose inverter with high-power
E002	Overcurrent during decelerating process	Decelerating time is too short	Prolong decelerating time
		Have potential energy load or big inertia load	Increase braking power of external energy consumption braking subassembly
		Power of inverter is a bit small	Choose inverter with high-power
E003	Overcurrent during constant speed process	Load change suddenly or Have unwonted phenomena	Check or reduce break of the load
		Accel/Decel time is set to too short	Prolong accelerating decelerating time properly
		Low power source voltage	Check input power supply
		Power of inverter is a bit small	Choose inverter with high-power
E004	Overvoltage during accelerating process	Unwonted input voltage	Check input power supply
		Accel time is set to too short	Prolong accelerating time properly
		Restart rotating motor	Set speed checking restart function
E005	Overvoltage during decelerating process	Decelerating time is too short	Prolong decelerating time
		Have potential energy load or big inertia load	Increase braking power of external energy consumption braking subassembly
E006	Overvoltage	Unwonted input voltage	Check input power supply

	during constant speed process	Accel/Decel time is set to too short	Prolong accelerating decelerating time properly
		Input voltage change abnormally	Assemble reactor
		Load inertia is a bit big	Use energy consumption subassembly
E007	Controlpower supply overvoltage	Unwonted input voltage	Check input power supply or look for service
E008	Inverter overload	Accel time is set to too short	Prolong accelerating time
		DC injection braking is too big	Reduce DC injection braking Current, prolong braking time
		Improper V/F curve	Adjust V/F curve and torque boost
		Restart rotating motor	Set speed checking restart function
		Power source voltage is too low	Check power source voltage
		Load is too big	Choose inverter with high-power
E009	Motor overload	Improper V/F curve	Adjust V/F curve and torque boost
		Power source voltage is too low	Check power source voltage
		General motor run at low speed with big load	Can choose frequency conversion motor for long time low speed run
		Motor overload protection factor set incorrectly	To set motor overload protection factor correctly
		Motor blocked up or load change too suddenly and quickly	Check the load
E010	Inverter over heating	Air-path blocked	To clear air-path or improve ventilation condition
		Ambient temperature is too high	Improve ventilation condition, lower carrier frequency
		Fan damaged	Replace the fan
E011	Reserved	Reserved	Reserved
E012	Input phase loss	Three-phase input power is abnormal	Check the three-phase input power cord whether is disconnected or has poor contact
		Power board is abnormal	Seek service from the manufacturer or agents
		The main control board is abnormal	Seek service from the manufacturer or agents
E013	Inverting module	Transient overcurrent of the inverter	Refer to countermeasure for overcurrent

	protection	Phase to phase short circuit or earthing short circuit of output 3 phase	wiring again
		Air-path blocked or fan damaged	To clear air-path or replace the fan
		Ambient temperature is too high	Lower ambient temperature
		Connecting wire or insert on control board loose	Check and connect the wire again
		Unwonted current wave caused by missing output phase etc.	Check wiring
		Assistant power supply damaged and drive voltage lacking	Look for service from manufacturer or agent
		Unwonted control board	Look for service from manufacturer or agent
E014	External device failure	Use sudden stop  key in non-keypad run mode	Look up operation mode
		Use sudden stop  key under condition of stall	Set running parameter correctly
		Sudden stop terminal for external failure closed	Open external failure terminal after external failure is settled
E015	Current detecting circuit failure	Connecting wire or insert on control board loose	Check and connect the wire again
		Assistant power supply damaged	Look for service from manufacturer or agent
		Hall component damaged	Look for service from manufacturer or agent
		Unwonted amplifying circuit	Look for service from manufacturer or agent
E016	RS485 communication failure	Baud rate set improperly	set Baud rate properly
		Serial port communication error	press  key to reset, look for service
		Failure warning parameter set improperly	Modify F2.16, F2.17
		Upper device doesn't work	Check if upper device work and wiring is correct
E017	PID Disconnection fault	PID feedback amount lost	Check the PID feedback loop wiring is good or not
		PID value instantly becomes very small	Check the equipment abnormal or not
E018	Reserved	Reserved	Reserved

E019	Under voltage	Under voltage	Check spot input voltage
E020	System disturbance	Serious disturbance	Reset by pressing  key or add mains filter at power supply input side
		Main control DSP read and write wrongly	Reset by the key-press, look for service
E021	Reserved	Reserved	Reserved
E022	Reserved	Reserved	Reserved
E023	E ² PROM read and write wrongly	Mistake take place when read or write control parameter	Reset by pressing  Look for service from manufacturer or agent
P.OFF	Under voltage	Under voltage	check spot input voltage

7.2 Failure record lookup

This series inverter can record latest 6 failure code and inverter run parameter of the last failure, to search these informations can redound to finding out reason of the failure.

Failure information is all stored in Fd group parameter, please enter into Fd group parameter to see about information by referring to keypad operation method.

Code	Content	Code	Content
Fd.00	Previous one failure record	Fd.08	Output current at previous failure
Fd.01	Previous two failure record	Fd.09	Output volt. at previous failure
Fd.02	Previous three failure record	Fd.10	DC bus-bar vlot. at previous failure
Fd.03	Previous four failure record	Fd.11	Load motor speed at previous failure
Fd.04	Previous five failure record	Fd.12	Module temp. at previous failure
Fd.05	Previous six failure record	Fd.13	Input end state at previous failure
Fd.06	Set freq. at previous failure	Fd.14	Accu. runtime at previous failure
Fd.07	Output freq. at previous failure	-	-

7.3 Failure reset



- (1) Before reset you must find out reason of failure downright and eliminate it, otherwise may cause permanent damage to the inverter.
- (2) If can't reset or failure takes place again after resetting, should look for reason and continuous resetting will damage the inverter.
- (3) Reset should take place 5 minutes after overload, overheat protection action.

To resume normal running when failure takes place in the inverter, you can choose following any kind of operation:

- (1) Set any one terminal of X1~X5 to external RESET input (F5.00~F5.04=11),

open it after connected to COM.

(2) When failure code is displayed, press  key after restoration is confirmed.

(3) Cut off power supply.

ENC

8 Maintenance

8.1 Routine maintenance

When you use EDS800 series you must assemble and operate it according to demand listed in this 《Service manual》 strictly. During run state, temperature, humidity, vibration and aging parts may affect it. To avoid this, it is recommended to perform routine inspections.

Table 8-1 Daily inspection items

Period		Inspection item	Inspection content	Criterion
Daily	Periodic			
√		Run state parameter	(1) Output current	(1) Within range of rated value
			(2) Output voltage	(2) Within range of rated value
			(3) Inside temp.	(3) Temp. increment < 35℃
√		Cooling system	(1) Installing ambient	(1) Good ventilation, unblocked air-path
			(2) Local fan	(2) Rotate normally without abnormal noise
√		Motor	(1) Heating	(1) No abnormality
			(2) Noise	(2) Even
	√	Inverter	(1) Vibration, heating	(1) Vibration balanced, proper wind temp.
			(2) Noise	(2) Without abnormal sound
			(3) Fixation of lead, terminal	(3) Fixed screw don't loose
√		Run ambient	(1) Temperature, humidity	(1)-10℃~+40℃ 40℃~50℃ used in lower volume or execute compulsory heat dissipating
			(2) Dust, water and leakage	(2) No water leakage imprint, no dust
			(3) Gas	(3) No peculiar smell

Recommend to inspect with following instrument:

Input voltage: electric voltmeter; output voltage: rectifying voltmeter; input output current: pincers ammeter.

8.2 Inspection and replacement of damageable parts

Some component parts in the inverter will be abraded or bear descending performance for long-term usage, to assure that the inverter can run stably and reliably, it is recommended to perform defending maintenance and replace corresponding parts if necessary.

(1) Cooling fan

Abnormal noise, even oscillation may take place if the fan have wearing bearing, aging blade, here replacement of the fan should be considered.

(2) Filter electrolyte capacitance

When frequent-changing load causes increasing pulsant current and aging electrolyte under high ambient temperature, the electrolyte capacitance may be damaged and here should replace it.

8.3 Repair guarantee

(1) We provide the free maintenance within warranty time if any failure or damage under normal usage, the warranty time can be seen in the warranty card, we will charge some when exceed warranty time.

(2) We will take some upkeep if one of following situations takes place within period of repair guarantee.

a. If did not use the inverter according to《service manual》strictly or did not use it under ambient demanded in 《service manual》, which cause failure.

b. Failure caused by applying the inverter to non-normal function;

c. Failure caused by self-repair, refit which is not already allowed;

d. Damage caused by bad keeping, falling down from high place or other extrinsic factor after purchasing the inverter;

e. Failure caused by natural disaster or its reason such as unwonted voltage, thunderbolt, water fog, fire, salt corroding, gas corroding, earthquake and storm etc.;

f. Make bold to tear up product logo (such as: nameplate etc.); Body serial number don't accord with that in repair guarantee card.

(3) We calculate service fee based on actual cost, which is subject to contract if any.

(4) You can contact the agent and also our company directly if you have questions. After repair guarantee period, we shall also provide lifetime charged repair service for our products.



Our company will also provide lifetime repair service with fee for inverter which is not within period of repair guarantee.

8.4 Storage

The user must pay attention to following points for temporary storage and long-term storage after purchasing the inverter:

(1) Avoid storing the inverter in high temperature, moist place and place of dust, metal powder and assure good ventilation.

(2) Longtime storage will cause electrolyte capacitance of low quality, so must assure that it's electrified for one time within 2 years and electrification time is not shorter than 5 hours and input voltage must be increased to rated value gradually by voltage adjustor.

9 Examples

9.1 Common speed regulation running

9.1.1 Basic wiring diagram

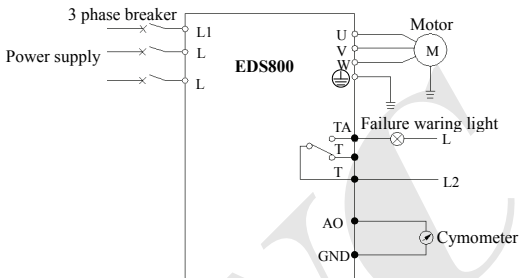

Fig. 9-1

9.1.2 Set following basic parameter:

- (1) Set parameter F8.01~F8.06 according to rated value of the inverter.
- (2) Set F0.00 parameter to 0, choose keypad analog potentiometer to set frequency.
- (3) Set F0.02 parameter to 0, choose keypad to control start-up, stop.
- (4) Use F0.03 parameter to set run direction.



Note

- (1) Press key to set frequency.
- (2) To press key, the inverter will stop.
- (3) To press key, inverter enter into next menu or confirm data.
- (4) Press key to increase or decrease the data.

9.1.3 Realized function

- (1) Realize stepless speed regulation to the motor, use keypad to control start/stop and keypad analog potentiometer to adjust frequency.
- (2) Bear failure warning function.
- (3) Connect with cymometer, which indicates output frequency of the inverter.

9.1.4 Application field

Used for common speed regulation field, such as: transportation machine, china machine, baccy machine, metallurgy machine etc.

9.2 Terminal control running

9.2.1 Basic wiring diagram

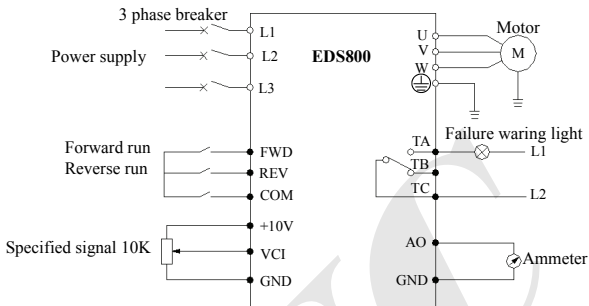

Fig. 9-2

9.2.2 Parameter setting

- (1) Set parameter F8.01~F8.06 according to rated value of the inverter.
- (2) Set F0.00 parameter to 4, 5 to choose VCI, CCI accordingly, can accept frequency set signal within 0~10V.
- (3) Set F0.02 parameter to 1, to choose terminal run command channel.



Note

- (1) If F5.08=0, namely 2 wire control mode 1, FWD and COM are closed, motor is in forward run; REV and COM are closed, motor is in reverse run FWD, REV and COM are closed or opened together, the inverter stop.
- (2) Set frequency is specified through VCI analog channel.

9.2.3 Realized function

- (1) Control forward run/reverse run of the motor by external on-off quantum.
- (2) Control speed of the motor by 0~10V signal.
- (3) Bear failure warning and output current indication function.

9.2.4 Application field

Used in field where need long-distance control to start/stop of the motor such as blower, food, chemical machine, packing machine, transportation machine etc.

9.3 Multi-step speed control running

9.3.1 Parameter setting

- (1) Set parameter F8.01-F8.06 according to rated value of the inverter. set F0.02 parameter to 1, to choose terminal run command channel.
- (2) F2.30-F2.44: multi-step speed frequency setting.
- (3) F5.00-F5.04 set multi-step speed terminal control function.

(1) If F5.08=0, namely 2 wire control mode 1: FWD and COM are closed, motor is in forward run; REV and COM are closed, motor is in reverse run; FWD, REV and COM are closed or opened together, the inverter stop.

(2) If any one or more terminal of X1, X2, X3 and COM are closed together, the inverter will run according to multi-step speed frequency determined by X1, X2, X3 (multi-step speed frequency set value are determined by F2.30-F2.44). Can realize manual control and automatic control for multiple frequency, and also control for forward run, reverse run, free stop, reset, warning protection.

9.3.2 Basic wiring diagram

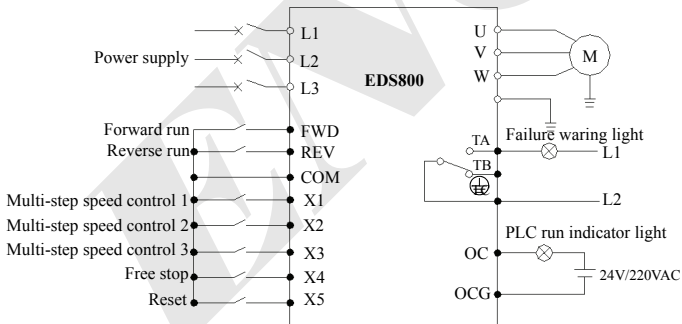

Fig.9-3

9.3.3 Realized function

- (1) Make use of external on-off quantum signal to control start/stop of the motor.
- (2) Make use of external on-off quantum signal to make the motor run at set frequency.
- (3) Bear free stop and reset function by utilizing external on-off quantum signal.
- (4) Bear warning alarm and PLC run indication function.

9.3.4 Application field:

Applied in field where need frequent multi-speed adjustment to motor speed such as toughened glass, weaving, paper making, chemical etc..

9.4 Closed-loop control system

9.4.1 Parameter setting

- (1) Set parameter F8.01~F8.06 according to rated value of the inverter.
- (2) F3.00=1: setting channel selection, here PID closed loop run control is effective.
- (3) F3.01=1: setting channel selection, here choose VCI as provision channel of PID adjuster.
- (4) F3.02=1: feedback channel selection, here choose CCI as feedback channel, 4-20mA/0-10V feedback signal.
- (5) F3.08~F3.10, set according to spot requirement.

9.4.2 Basic wiring diagram

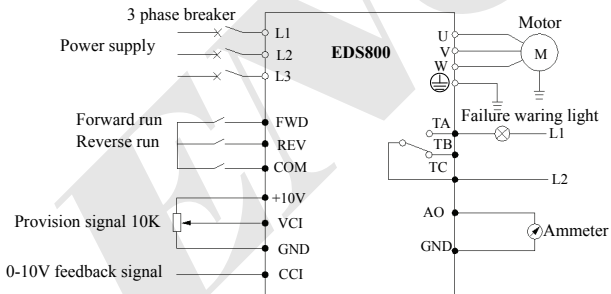

Fig.9-4

9.4.3 Realized function

- (1) The inverter can adjust output automatically according to feedback signal to make constant voltage, constant temperature, constant current etc. available.
- (2) Can control Start/Stop of the motor from long distance.
- (3) Bear failure alarm and current indicator function.

9.4.4 Application field

Applied in field where need stable system, pressure, flux such as blower pump, constant pressure water supply, air compressor, air conditioner, freezer cooling tower, music fountain, heat supply etc..

9.5 Consecutive action running

9.5.1 Basic wiring diagram

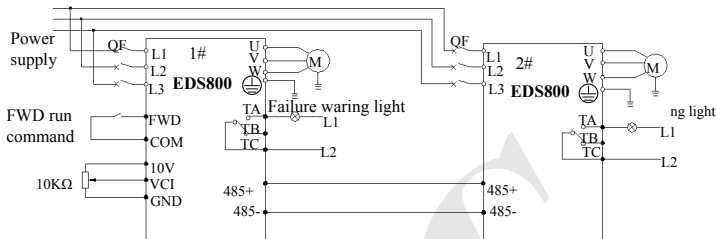

Fig.9-5

9.5.2 Parameter setting

Set 1# inverter as follows:

- (1) F0.02=1: terminal run command control.
- (2) F5.23=0: DO terminal output pulse signal for 1# inverter output frequency.
- (3) F5.10=0: 1# inverter running signal is outputted by digital output terminal OC.

set 2# inverter as follows:

- (5) F0.00=7: terminal pulse setting is frequency provision for 2# inverter.
- (6) F0.02=1: terminal run command control.
- (7) F5.04=38: X5 is for pulse frequency input.

After above setting, can use digital/pulse output quantum of 1# inverter to realize consecutive action of 2# inverter.

9.5.3 Operation description

After receive forward run command from external switch (closed) and frequency specified value (0~10V) from analog input terminal VCI, 1# inverter run at this frequency value. At the same time, already running state of 1# inverter, make 2# inverter get forward run command through open circuit collector output end OC, here, run frequency value from high-speed pulse output terminal of 1# inverter is passed to 2# inverter through X5 terminal.

9.5.4 Application field

Applied in field such as conveyer belt, coiler, factory production line, food chemistry, piece drawer etc.

10 Modbus communication protocol

10.1 Summarization

We provide general RS485 communication interface in our inverters (such as EDS800 series, EDS1000 series and etc.) for the user. Through this communication interface upper device (such as HMI, PC, PLC controller and etc.) can perform centralized monitor to the inverter (such as to set inverter parameter, control run of inverter, read work state of the inverter).

This communication protocol is interface criterion file designed for realizing above-mentioned function, please read it earnestly and program according to it so that realize long-distance and network control to the inverter.

10.2 Communication net buildup mode

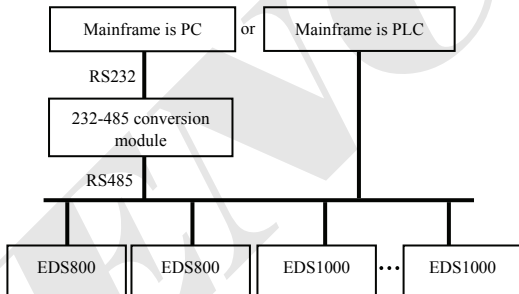

Fig.10-1 Net buildup graph

10.3 Communication mode

At present, EDS800 inverter can be used only as auxiliary device in RS485 net.

Can realize communication between inverters through PC, PLC or HMI if it's needed. Specific communication mode is as mentioned below:

(1) PC or PLC as mainframe, inverter as auxiliary device, point-to-point communication between mainframe and auxiliary device.

(2) Auxiliary device don't response when mainframe send out command by broadcast address.

(3) User can set local address, baud rate and data format of the inverter through auxiliary device keypad or serial communication mode.

(4) EDS800 provides optional RS485 interface.

(5) Default mode: Asynchronous serial, semiduplex transport mode. RTU mode. Default format and transport rate: 8-N-1, 9600bps.

10.4 RTU Communication Mode:

10.4.1 Data frame format

Using RTU mode, messages are sent at least 3.5 character time interval pause. The first transmitted field is device address, the character you can transfer is hexadecimal 0x00 ~ 0xFF. Network equipment continuously monitor the bus, including pauses. When the address field is received, all equipment determine whether it is sent to their own. When the last character of the packet transfer is complete, at least a 3.5 character times pause mean the end of the message. A new message can begin after this pause.

The entire message frame must be transmitted as a continuous flow. If a new message start transmitting in less than 3.5 character times after a message and then receiving device will consider it a continuation of the previous message. This will cause an error, because in the final CRC field value can not be right.

RTU frame format as the table below:

Frame Header	3.5 characters time pause
Slave address	Slave value: 1~127
Communication command code	03H: read slave parameter 06H: write slave parameter
Data content DATA	The contents of packet:
Data content DATA	Parameter address (16bit) ;
.....	Number of parameter or bytes of parameter value;
.....	Parameter value (16bit)
CRC check value low byte	16bit Unsigned check value
CRC check value high byte	
Closing Flag	3.5 characters time pause

Regarding generation method of CRC check value, please refer to part 10.8 for check method.

10.4.2 Host read slave parameter

Command code 03H. Host can read or one or more parameter(up to ten) by initiating a communication transaction .

E.g., read 2 contiguous inverter parameter values from the address 0000H of inverter whose address is 01, the contents of host command:

ADR	01H
CMD	03H
Parameters initial address high byte	00H
Parameters initial address low byte	00H
Number of parameter high byte	00H

Number of parameter low byte	02H
CRC check value low byte	Be calculated
CRC check value high byte	Be calculated

The contents of slave reply:

ADR	01H
CMD	03H
Parameter value bytes	04H
Address 0000H content high byte	00H
Address 0000H content low byte	01H
Address 0001H content high byte	13H
Address 0001H content low byte	88H
CRC check value low byte	Be calculated
CRC check value high byte	Be calculated

10.4.3 Host write slave parameter

Command code 06H. Host can write an parameter by initiating a communication transaction.

E.g.,The decimal system 5000 (1388H) written to the inverter 0001H address whose slave address is 02, host command including:

ADR	02H
CMD	06H
Parameter address high byte	00H
Parameter address low byte	01H
Parameter value high byte	13H
Parameter value low byte	88H
CRC check value low byte	Be calculated
CRC check value high byte	Be calculated

The contents of slave reply:

ADR	02H
CMD	06H
Parameter address high byte	00H
Parameter address low byte	01H
Address 0903H content high byte	13H
Address 0903H content low byte	88H
CRC check value low byte	Be calculated
CRC check value high byte	Be calculated

10.5 Data communication address allocation

10.5.1 Function code Fd-F0 group communication address

Inverter function parameter's MODBUS communication address addressing process follows PPnn way: PP means high byte of the address, corresponding to function parameter's group number; nn means low byte of the address, corresponding to function code parameter's group internal code. For example: F3.21 function code's communication address is 0315H, 03H is the hex form of group number 3, 15H is the hex form of group internal code 21.

F0.00~F9.11 communication address is 0000H~090BH, Fd group fault record parameter start address is 0D00H.

10.5.2 Control command and status word communication address

Variable Name	Communication address	Reading-writing attribute	Command data or response value meaning
Run command word	2000H	Writing only	1: Inching run
			2: Inching stop
			3: Forward inching run
			4: Reversal inching run
			5: Run
			6: Stop
			7: Forward run
			8: Reversal run
			9: Fault reset
			10: Emergency stop
Serial port frequency provision	2001H	Reading and writing	Lower frequency ~ upper frequency
Inverter status	2100H	Reading only	1: Forwarder running 2: Reversal running 3: Stop 4: Alarm status
Alarm code	2180H	Reading only	0: Without alarm 1~23:mean E001~E023 alarm

10.5.3 Monitor parameter communication address

Monitor parameter	Name	Communication address (Reading only)
C-00	Set frequency	1000H
C-01	Output frequency	1001H
C-02	Output current	1002H
C-03	Output voltage	1003H
C-04	DC bus-bar voltage	1004H
C-05	Load motor speed	1005H
C-06	module temperature.	1006H
C-07	Power on running time	1007H

C-08	Accumulative running time	1008H
C-09	Input terminal status	1009H
C-10	Output terminal status	100AH
C-11	Analog input VCI value	100BH
C-12	Analog input CCI value	100CH
C-13	reserved	
C-14	External impulse frequency	100EH

10.6 Communication error processing

Inverter receiving data packet detection error, it finds reading & writing parameter address or parameter value invalid, so reply to the host with communication error response packet. Communication error response packet (host command code +80H) as command code, with 1 byte error code.

Format for communication error response packet as follows:

ADR	01H
CMD	83H/86H
communication error code	01H~06H (for details, please check below table)
Low byte of CRC checksum	Obtain by calculating
High byte of CRC checksum	Obtain by calculating

Meaning for each communication error code value as follows:

Communication error code value	Type of communication error
0x01	CRC checksum error
0x02	Command code illegal
0x03	Register address visited illegal
0x04	Value to register illegal
0x05	Not allow to modify parameters
0x06	Register number read illegal

10.7 Data frames examples

10.7.1 Start 1# inverter running

Data Field	Auxiliary Inverter Address	Order code	Register address High byte	Register address Low byte	Data High byte	Data Low byte	CRC high bit	CRC Low bit
Host command frames	01	06	20	00	00	05	42	09
Auxiliary respond frames	01	06	20	00	00	05	42	09

10.7.2 Stop 1# inverter running

Data Field	Auxiliary Inverter Address	Order code	Register address High byte	Register address Low byte	Data High byte	Data Low byte	CRC high bit	CRC Low bit
host command frames	01	06	20	00	00	06	02	08
Auxiliary respond frames	01	06	20	00	00	06	02	08

10.7.3 Set 1# inverter given value to 50Hz

Data Field	Auxiliary Inverter Address	Order code	Register address High byte	Register address Low byte	Data High byte	Data Low byte	CRC high bit	CRC Low bit
host command frames	01	06	20	01	13	88	DE	9C
Auxiliary respond frames	01	06	20	01	13	88	DE	9C

10.7.4 Read 1# inverter running state

Data Field	Auxiliary Inverter Address	Order code	Register address High byte	Register address Low byte	Data High byte	Data Low byte	CRC high bit	CRC Low bit
Host command frames	01	03	21	00	00	01	8E	36
Auxiliary respond frames	01	03	(Respond value byte count) 02		00	00	B8	44

10.8 CRC checksum mode

CRC checksum value calculating function written by C language is as follows:
 unsigned int cal_crc_value (unsigned char *pval, unsigned char len)

```
{
  unsigned int crc_value=0xFFFF;
  unsigned int i;

  while(len--)
  {
    crc_value ^= *pval++;
```

```
for(i=0; i<8; i++)
{
    if(crc_value & 0x0001)
    {
        crc_value >>= 1;
        crc_value ^= 0xA001;
    }
    else
    {
        crc_value >>= 1;
    }
}
return(crc_value);
}
```

Appendix 1 Serial port 485 communication protocol

1.1 Summarization

We provide general RS485/RS232 communication interface in our inverters (such as EDS2000 series, EDS2800 series, EDS1000 series etc.) for the user. Through this communication interface upper device (such as PC, PLC controller etc.) can perform centralized monitor to the inverter (such as to set inverter parameter, control run of inverter, read work state of the inverter) and also long-distance control keypad can be connected to realize various usage requirement of the user.

This communication protocol is interface criterion file designed for realizing above-mentioned function, please read it earnestly and program according to it so that realize long-distance and network control to the inverter.

1.2 Protocol content and description

1.2.1 Communication net buildup mode

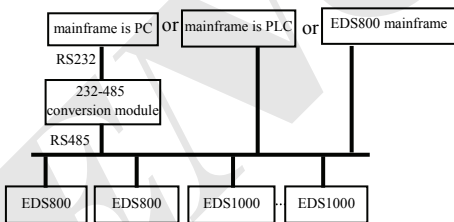

Fig.1 Net buildup graph

1.2.2 Communication mode

At present, EDS800 inverter can be used only as auxiliary device in 485 net. Can realize communication between inverters through PC or PLC if it's needed. Specific communication mode is as mentioned below:

- (1) PC or PLC as mainframe, inverter as auxiliary device, point-to-point communication between mainframe and auxiliary device.
- (2) Auxiliary device don't response when mainframe send out command by broadcast address.
- (3) User can set local address, baud rate and data format of the inverter through auxiliary device keypad or serial communication mode.
- (4) Auxiliary device report current failure information to mainframe in the last

response frame.

(5) EDS800 provides 485 interface.

1.2.3 Transport mode

Asynchronous serial, semiduplex transport mode. Default format and transport rate: 8-N-1, 9600bps. For specific parameter setting please see description for F2.14~F2.17 group function code.

(Remark: Below definition is only effective under series port RS485 communication mode, and definition for other parameters are the same as original)

F2.14	Communication configuration	LED first bit: baud rate selection 0: 1200BPS 1: 2400BPS 2: 4800BPS 3: 9600BPS 4: 19200BPS 5: 38400BPS LED second bit: data format 0: 1-8-1 format, no checkout 1: 1-8-1 format, even checkout 2: 1-8-1 format, odd checkout	1	03	×
F2.15	Local address	0~127, 127 is broadcast address	1	1	×
F2.16	Communication timeout detection time	0.0~1000.0s	0.1s	0.0s	×
F2.17	Local response delay	0~200ms	1ms	5ms	×

1.2.4 Data command frame format

Main device command frame format																		
Sending order	1	2	3	4	5	6	7	8	9	10	11	12	13	14	15	16	17	18
	Frame head	Auxiliary device address	Auxiliary device address	Main device command	Main device command	Assistant index	Assistant index	Command index	Command index	Set data	Set data	Set data	Set data	Checkout sum	Checkout sum	Checkout sum	Checkout sum	Frame end
Definition	Head	Address	Address	command area	command area	Index area	Index area	Index area	Index area	Setting data area	Setting data area	Setting data area	Setting data area	Checkout area	Checkout area	Checkout area	Checkout area	End

Sending byte	1	2	2	4	4	4	1
--------------	---	---	---	---	---	---	---

Auxiliary device response frame format																		
Sending order	1	2	3	4	5	6	7	8	9	10	11	12	13	14	15	16	17	18
	Frame head	Auxiliary device address	Auxiliary device address	Auxiliary device response	Auxiliary device response	Failure index	Failure index	Command index	Command index	Run data	Run data	Run data	Run data	Checkout sum	Checkout sum	Checkout sum	Checkout sum	Frame end
Definition	Head	Address	Response area		Index area				Run data area				Checkout area				end	
Sending byte	1	2	2	4				4				4				1		

Fig.1-2 Command/response frame format

Remark:

- (1) "Setting data area" and "run data area" may not be existent in some command/data frame format, so in protocol command list it's marked with "nothing".
- (2) In protocol effective character set is: ~, 1, 2, 3, 4, 5, 6, 7, 8, 9, A, B, C, D, E, F and hex data 0DH, ASCII lowercase a, b, c, d, e, f are invalid.
- (3) Effective command frame length is 14 or 18 byte.

1.2.5 Explanation and description for format

(1) Frame head

It's character "~" (namely hex 7E), single byte.

(2) Auxiliary device address

Data meanings: local address of auxiliary device, double byte. ASCII format. Inverter factory default is 01.

(3) Mainframe command/auxiliary device respond Data meanings: mainframe send out command and auxiliary device respond to the command. Double byte, ASCII format. Response code function classification:

Species 1>: Command code="10", mainframe ask auxiliary device to report current preparation state and control situation.

Table 1 Response code meanings for command code “10”

Response code ASCII	Meanings		
	Preparation state of auxiliary device	Control from mainframe is allowed	To set frequency is allowed
10	Don't get ready	No meaning	
11	Get ready	allow	allow
12	get ready	allow	allow
13	get ready	don't allow	don't allow
14	get ready	don't allow	don't allow
20	Frame error		

Species 2>: command code= “11” ~ “15” , 5 kinds of function command which mainframe send to auxiliary device, for detail please see protocol command list.

Table 2 Response code meanings for command code “11~15”

Response code ASCII	Meanings of response code	description
00	Auxiliary device communication and control is normal; function code modification is effective; password is correct.	
20	(1) Frame checkout error; (2) “Command area” data overrun; (3) “Index area” data overrun; (4) Frame length error/non ASCII byte exist in area except frame head, frame end.	When this response code is reported, data of “command area”, “index area” and “running data area” are not reported.
30	(1) Control to auxiliary device is Ineffective; (2) Ineffective function code parameter modification; (3) “Setting/running data” area data overrun. (4) Password error.	Whether report this response code relate to current set state of auxiliary device. When report data of area”, “Index area” and “Run data area” are reported according to protocol requirement.

(4) Auxiliary index/command index/failure index Data meanings: include auxiliary index byte and command index byte.

For mainframe, auxiliary index, command index are used for cooperating mainframe command in realizing specific function.

For auxiliary device, auxiliary index, command index are used for reporting failure state code, command index are reported without modification.

Data type: hex, 4 byte, ASCII format.

Command index occupy 2 low byte, data range: “00” ~ “FF” .

Auxiliary index occupy 2 high byte, data range: “00” ~ “FF” .

Auxiliary device failure state occupy “auxiliary index” byte, see Appendix table 3.

Table 3 Failure type description

Failure code	Description	Failure code	Description
1	Accelerating run over current	13	Converting module protection
2	Decelerating run over current	14	External device failure
3	Constant speed run over current	15	Current detecting circuit failure
4	Accelerating run over voltage	16	RS485 communication failure
5	Decelerating run over voltage	17	Reserved
6	Constant speed run over voltage	18	Reserved
7	Controller power supply over voltage	19	Under voltage
8	Inverter overload	20	System disturbance
9	Motor overload	21	Reserved
10	Inverter over heat	22	Reserved
11	Reserved	23	E ³ PROM read and write error
12	Reserved		

(5) Checkout sum

Data meanings: frame checkout, 4 byte, ASCII.

Calculation method: accumulative sum of ASCII code value of all byte from “auxiliary device address” to “run data”.

(6) Frame end

Hex 0D, single byte.

1.2.7 Protocol command list

Frame 7E and frame end 0D, address, checkout sum, ASCII character format are omitted in following description.

Table 4 Protocol command table

Name	Main-frame order	Auxiliary index	Order index	Run data setting range	Mainframe sending example` such as PC control operation of inverter(C language cluster format` auxiliary deviceaddress is set to 01)	Run data precision	Description
Look up auxiliary motor state	10	00	00	No	~010A00000192r	1	

Read parameter of auxiliary motor	Current set freq.	11	00	00	No	~010B00000193r	0.01Hz	
	Current run freq.	11	00	01	No	~010B00010194r	0.01Hz	
	Output voltage	11	00	02	No	~010B00020195r	1V	
	Output current	11	00	03	No	~010B00030196r	0.1A	
	Bus-bar voltage	11	00	04	No	~010B00040197r	1V	
	Load motor speed	11	00	05	No	~010B00050198r	1rpm	
	Module temp.	11	00	06	No	~010B00060199r	1 ⁰ C	
	Runtime	11	00	07	No	~010B0007019A r	1h	
	Accumulative time	11	00	08	No	~010B0008019B r	1h	
	Input terminal	11	00	09	No	~010B0009019C r	No	
	Output terminal	11	00	0A	No	~010B000A01A4 r	No	
	Analog input VCI	11	00	0B	No	~010B000B01A5 r	0.01V	
	Analog input CCI	11	00	0C	No	~010B000C01A6 r	0.01V	
	Reserved	11	00	0D	No	~010B000D01A7 r	0.01V	
Run control and adjusting function	Exterior pulse input	11	00	0E	No	~010B000E01A8 r	0.01Hz	
	Read inverter state	11	00	0F	No	~010B000F01A9 r	No	
	Auxiliary device run command	12	00	00	No	~010C00000194r	No	
	Set current run frequency provision of auxiliary device	12	00	01	0Hz~ high limit freq.	~010C00010FA0027C r	0.01Hz	Set freq. =40.00Hz
	Auxiliary device run with run freq. provision	12	00	02	0Hz~ high limit freq.	~010C00020FA0027D r	0.01Hz	Auxiliary device run set freq. =40.00Hz
	Auxiliary device forward run	12	00	03	No	~010C00030197r	No	
	Auxiliary device reverse run	12	00	04	No	~010C00040198r	No	
Auxiliary device forward run with run freq. provision	12	00	05	0Hz~ high limit freq.	~010C00050FA00280 r	0.01Hz	Forward run boot-strap set freq. =40.00Hz	
Auxiliary device reverse run with run freq. provision	12	00	06	0Hz~ high limit freq.	~010C00060FA00281 r	0.01Hz	Reverse run boot-strap set freq. =40.00Hz	

	Auxiliary device stop	12	00	07	No	~010C0007019B\ r	No	
	Auxiliary device jog run	12	00	08	No	~010C0008019C\ r	No	
	Auxiliary device forward jog run	12	00	09	No	~010C0009019D\ r	No	
	Auxiliary device reverse jog run	12		0A	No	~010C000A01A5\ r	No	
	Auxiliary device stop jog run	12	00	0B	No	~010C000B01A6\ r	No	
	Auxiliary device failure restoration	12	00	0C	No	~010C000C01A7\ r	No	
	Auxiliary device urgent stop	12	00	0D	No	~010C000E01A8\ r	No	
Read function code parameter	Run freq. digital setting F0.01	13	00	01	No	~010D00010196\ r	0.01Hz	
	Run direction setting F0.03	13	00	03	No	~010D00030198\ r	1	
	Accelerating time1 F0.08	13	00	0A	No	~010D000E01AA\ r	0.1S	
	Decelerating time1 F0.09	13	00	0B	No	~010D000F01AB\ r	0.1S	
Set function code parameter	Run freq. digital setting F0.01	14	00	01	0Hz~ high limit freq.	~010E00011388026B\ r	0.01Hz	Set function code F0.01= 50.00Hz
	Run direction setting F0.03	14	00	03	0, 1	~010E00030001025A\ r	1	Set function code F0.03 to reverse run
	Accelerating time1 F0.08	14	00	09	0~8CA0	~010E000E03E8028B\ r	0.1S	Set function code F0.08 to 10.0s
	Decelerating time1 F0.09	14	00	0A	0~8CA0	~010E000F03E8028C\ r	0.1S	Set function code F0.09 to 10.0s

Software version query order	Query auxiliary device software version	15	00	00	No	~010F00000197r	1	
------------------------------	---	----	----	----	----	----------------	---	--

Table 5 Response state word meanings of reading inverter state command

Bit	Signification		
	Description	0	1
Bit0	Stop/run state	Stop	Run
Bit1	Logo for under voltage	Normal	Under voltage
Bit2	FWD/REV run logo	Forward run	Reverse run
Bit3	traverse run mode logo	Ineffective	Effective
Bit4	Common run mode logo	Ineffective	Effective
Bit5	Jog run mode logo	No	Jog
Bit6	PLC run mode logo	No	Yes
Bit7	Multi-step freq. run mode logo	No	Yes
Bit8	PI closed loop run mode logo	No	Yes
Bit9	Set counting value arriving logo	No	Yes
Bit10	Specified counting value arriving logo	No	Yes
Bit11~15	Reserved		

Table 6 Read auxiliary device function code parameter

Function definition	Read auxiliary device function code parameter: all function code parameter except user password and manufacturer password						
Meanings	Frame head	Address	Order	Order index	Run data	Checkout sum	Frame end
Mainframe order	7EH	ADDR	13	See remark	None	BCC	0DH
Byte	1	2	2	4	0	4	1
Auxiliary device respond	7EH	ADDR	06	See remark	Function code para.	BCC	0DH
Byte	1	2	2	4	4	4	1
Remark	Command index=combined by function code group number and hex code of function code number. For instance: If want to read parameter of F0.05 function code, order index=000B; If want to read parameter of F2.11 function code, order index =020B; If want to read parameter of F2.15 function code, order index =0212; If want to read parameter of F2.13 function code, order index =0210;						
	Corresponding relation between decimal and hex value of function code group No.						

	Function group	Decimal	Hex	Function group	Decimal	Hex
	F0	0	00H	F6	6	06H
	F1	1	01H	F7	7	07H
	F2	2	02H	F8	8	08H
	F3	3	03H	F9	9	09H
	F4	4	04H	FD	13	0DH
	F5	5	05H	FF	15	0FH
Virtual data	0~FFFF (namely 0~65535)					

Please input correct “user password” before you set user function code parameter.

Table 7 Set auxiliary device function code parameter

Function definition	Set auxiliary device function code parameter: all function code parameter except user password and manufacturer password						
Meanings	Frame head	Address	Order	Order index	Run data	Checkout sum	Frame end
Mainframe order	7EH	ADDR	14	see remark	No	BCC	0DH
Byte quantity	1	2	2	4	0	4	1
Auxiliary device respond	7EH	ADDR	06	see remark	Function code para.	BCC	0DH
Byte quantity	1	2	2	4	4	4	1
Remark	Command index=combined by function code group number and hex code of function code number. For instance: If want to set parameter of F0.05 function code, order index=000B; If want to set parameter of F2.11 function code, order index =020B; If want to set parameter of F2.15 function code, order index =0212; If want to set parameter of F2.13 function code, order index =0210;						
	Corresponding relation between decimal and hex value of function Code group No.						
	Function group	Decimal	Hex	Function group	Decimal	Hex	
	F0	0	00H	F6	6	06H	
	F1	1	01H	F7	7	07H	
	F2	2	02H	F8	8	08H	
	F3	3	03H	F9	9	09H	
	F4	4	04H	FD	13	0DH	
	F5	5	05H	FF	15	0FH	
	Virtual data	0~FFFF (namely 0~65535)					

Appendix 2 Braking resistance

1.1 Braking resistance

The motor's electric potential energy will charge inverter's capacitance up reversely if speed of the motor decends too quickly or load of the motor wobbles too quickly while the inverter is running, which will increase the voltage upon power modules suddenly and is easy to make the inverter damaged. The inverter will control it according to load size and performance. You have to connect external resistance to realize timely energy discharge when the braking is not enough. To connect external resistance is a kind of energy consumption braking mode, as all the energy is consumed by the braking resistance.

EDS800-2S0002NB ~ EDS800-2S0015NB 、 EDS800-4T0007NB 、 EDS800-4T0015NB have built-in braking unit, EDS800-2S0022N 、 EDS800-4T0022N、 EDS800-4T0037N, the built-in braking unit is optional and you can add external braking resistance ,but the external resistance need booking.

External braking resistance configuration table

Type	Built-in braking unit	Braking resistance	Qty.	Power of braking resistance	Remark
EDS800-2S0002NB	Built-in	500Ω	1	60W	External braking resistance
EDS800-2S0004NB	Built-in	500Ω	1	60W	External braking resistance
EDS800-2S0007NB	Built-in	500Ω	1	60W	External braking resistance
EDS800-2S0015NB	Built-in	500Ω	1	60W	External braking resistance
EDS800-2S0022N	Optional	300Ω	1	1KW	External braking resistance
EDS800-4T0007NB	Built-in	800Ω	1	60W	External braking resistance
EDS800-4T0015NB	Built-in	800Ω	1	60W	External braking resistance
EDS800-4T0022N	Optional	300Ω	1	1KW	External braking resistance
EDS800-4T0037N	Optional	125Ω	1	2KW	External braking resistance



ENC Shenzhen Encom Electric Technologies CO., LTD.

Address: Floor 6, Building 2 West, Pingshan Minqi Science & Technology Park, Taoyuan Str., Nanshan District, Shenzhen, China

Website: www.encvfd.com

E-mail: encvfd@encvfd.com

encvfd@enc.net.cn

Tel: +86-755-26984485

Fax: +86-755-26985120